

# MAX11192

## 12-Bit, 2MSPS, Dual Simultaneous Sampling SAR ADCs with Internal Reference

### General Description

The MAX11192 is a dual-channel SAR ADC with simultaneous sampling at 2MSPS, 12-bit resolution, and differential inputs. Available in a tiny 16-pin, 3mm x 2mm ultra TDFN package, this ADC delivers excellent static and dynamic performance while operating from a supply voltage over the range of 3.0V to 5.25V. An integrated reference further reduces board area and component count.

The MAX11192 achieves 73dB of SNR (min), -108dB of THD (typ), and INL less than  $\pm 0.5$ LSB with no missing codes. The SPI-compatible serial interface includes a separate data output for each channel. Specifications apply over the extended industrial temperature range of  $-40^{\circ}\text{C}$  to  $+125^{\circ}\text{C}$ .

### Applications

- Encoders
- Resolvers
- LVDT
- Current Sensing in Motors
- PLC

### Application Diagram

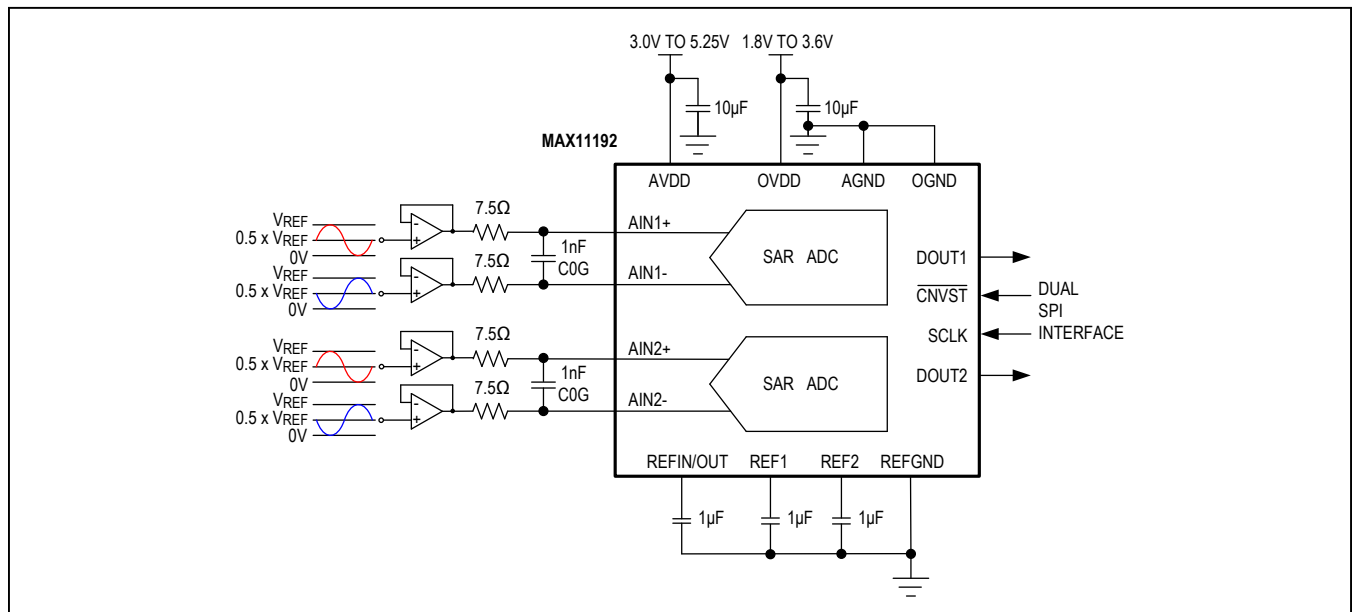

### Benefits and Features

- Tiny 16-Pin, 3mm x 2mm, Ultra TDFN Package
- Up to 2MSPS Throughput Rate
- Two Simultaneous-Sampling ADC Cores
- 2.5V Integrated Reference and Reference Buffers
- Two Data Outputs for the Two Simultaneous-Sampling ADCs
- No Overhead Clock Cycles; 12 Clock Cycles for 12-Bit Result
- Balanced, Differential Input Range of  $\pm V_{REF}$
- 73dB SNR (min), -108dB THD (typ) at 10kHz
- $INL < \pm 0.5$ LSB, No Missing Codes

*Ordering Information* appears at end of data sheet.

**Absolute Maximum Ratings**

AVDD to GND, REFGND, OGND .....-0.3V to +5.5V  
 OVDD to GND, REFGND, OGND.....-0.3V to +5.5V  
 AINn+, AINn- to GND, REFGND, OGND.. -0.3V to The lower of (V<sub>AVDD</sub> + 0.3V) and +5.5V  
 REF1N, REF1P, REF2N, REF2P to GND, REFGND, OGND.....-0.3V to The lower of (V<sub>AVDD</sub> + 0.3V) and +5.5V  
 CNVST, SCLK, DOUT1, DOUT2 to OGND.....-0.3V to The lower of (V<sub>OVDD</sub> + 0.3V) and +5.5V  
 GND to REFGND to OGND .....-0.3V to +0.3V

Maximum Current Into Any Pin .....-50mA to +50mA  
 Continuous Power Dissipation (16 UTDFN; T<sub>A</sub> = +70°C; derate 16.7mW/°C above +70°C) ( ) .....1333mW  
 Operating Temperature Range.....-40°C to 125°C  
 Junction Temperature.....+150°C  
 Storage Temperature Range.....-65°C to +150°C  
 Lead Temperature (soldering, 10s) .....+300°C  
 Soldering Temperature (reflow).....+260°C

*Stresses beyond those listed under "Absolute Maximum Ratings" may cause permanent damage to the device. These are stress ratings only, and functional operation of the device at these or any other conditions beyond those indicated in the operational sections of the specifications is not implied. Exposure to absolute maximum rating conditions for extended periods may affect device reliability.*

**Package Information**

**16 Ultra TDFN**

<b>PACKAGE CODE</b>	<b>T1623CN+1</b>
Outline Number	<a href="#">21-100030</a>
Land Pattern Number	—
<b>Thermal Resistance, Four-Layer Board:</b>	
Junction to Ambient (θ <sub>JA</sub> )	60
Junction to Case (θ <sub>JC</sub> )	11

For the latest package outline information and land patterns (footprints), go to [www.maximintegrated.com/packages](http://www.maximintegrated.com/packages). Note that a "+", "#", or "-" in the package code indicates RoHS status only. Package drawings may show a different suffix character, but the drawing pertains to the package regardless of RoHS status.

Package thermal resistances were obtained using the method described in JEDEC specification JESD51-7, using a four-layer board. For detailed information on package thermal considerations, refer to [www.maximintegrated.com/thermal-tutorial](http://www.maximintegrated.com/thermal-tutorial).

**Electrical Characteristics**

(f<sub>Sample</sub> = 2MSPS; V<sub>AVDD</sub> = 5.0V, V<sub>OVDD</sub> = 1.8V; V<sub>REFIN/OUT</sub> = 2.5V (Internal Reference); T<sub>A</sub> = T<sub>MIN</sub> to T<sub>MAX</sub> (Note 1). Typical values are at T<sub>A</sub> = +25°C, unless otherwise noted.)

PARAMETER	SYMBOL	CONDITIONS	MIN	TYP	MAX	UNITS
<b>ANALOG INPUTS</b>						
Input Voltage Range	V <sub>IN(DIFF)</sub>	AINn+ – AINn-		±V <sub>REF</sub>		V
Absolute Input Voltage Range	V <sub>IN(RNG)</sub>	AINn+/AINn- relative to GND	-0.1		V <sub>AVDD</sub> + 0.1	V
Common-Mode Input Voltage Range	CM <sub>IRNG</sub>	(AINn+ + AINn-)/2	V <sub>REF</sub> /2 - 0.1		V <sub>REF</sub> /2 + 0.1	V
Input Leakage Current	I <sub>IN_LEAK</sub>	Acquisition phase		1		µA
Input Capacitance	C <sub>IN</sub>			10		pF

**Electrical Characteristics (continued)**

( $f_{\text{Sample}} = 2\text{MSPS}$ ;  $V_{\text{AVDD}} = 5.0\text{V}$ ,  $V_{\text{OVDD}} = 1.8\text{V}$ ;  $V_{\text{REFIN/OUT}} = 2.5\text{V}$  (Internal Reference);  $T_{\text{A}} = T_{\text{MIN}}$  to  $T_{\text{MAX}}$  (Note 1). Typical values are at  $T_{\text{A}} = +25^{\circ}\text{C}$ , unless otherwise noted.)

PARAMETER	SYMBOL	CONDITIONS	MIN	TYP	MAX	UNITS
<b>STATIC PERFORMANCE (VREFIN/OUT = 2.5V, INTERNAL REFERENCE)</b>						
Resolution	N		12			Bits
No Missing Codes			12			Bits
Offset Error	OE		-1		+1	LSB
Offset Error TC				1.2		mLSB/ $^{\circ}\text{C}$
Gain Error	GE	(Note 2)	-1		+1	LSB
Gain Error TC		(Note 2)		1.2		mLSB/ $^{\circ}\text{C}$
Integral Nonlinearity	INL		-0.5		+0.5	LSB
Differential Nonlinearity	DNL		-0.25		+0.25	LSB
Analog Input CMR		Common Mode Range; $V_{\text{REF}/2} - 100\text{mV}$ to $V_{\text{REF}/2} + 100\text{mV}$		40		mLSB/V
Power-Supply Rejection	PSRR	AVDD		3		LSB/V
Power Supply Rejection	PSRR	OVDD		3		LSB/V
<b>INTERNAL REFERENCE</b>						
Initial Accuracy		$T_{\text{A}} = +25^{\circ}\text{C}$	2.498	2.500	2.502	V
Temperature Drift				5		ppm
<b>EXTERNAL REFERENCE</b>						
Input Voltage Range		External reference applied to REFIN	2.5		$V_{\text{AVDD}} - 0.25$	
		External reference applied to REF1 or REF2	2.5		$V_{\text{AVDD}} + 0.1$	V
<b>REFERENCE BUFFERS</b>						
Bypass Capacitor			4.7			$\mu\text{F}$
<b>DYNAMIC PERFORMANCE (VREFIN/OUT = 2.5V, INTERNAL REFERENCE)</b>						
Signal-to-Noise Ratio	SNR	10kHz input	73			dB
Signal-to-Noise And Distortion Ratio	SINAD	10kHz input		73.5		dB
Spurious-Free Dynamic Range	SFDR	10kHz input		102		dB
Total Harmonic Distortion	THD	10kHz input		-108		dB
Crossalk		10kHz input		-100		dB
<b>DYNAMIC PERFORMANCE (VREFIN/OUT = 4.096V, EXTERNAL REFERENCE)</b>						
Signal-to-Noise Ratio	SNR	10kHz input	73			dB
Signal-to-Noise And Distortion Ratio	SINAD	10kHz input		73.5		dB
Spurious-Free Dynamic Range	SFDR	10kHz input		102		dB
Total Harmonic Distortion	THD	10kHz input		-108		dB
Crossalk		10kHz input		-100		dB
<b>SAMPLING DYNAMICS</b>						
Throughput					2	Msps
Aperture Delay Match				150		ps
Input -3db Bandwidth	$f_{-3\text{dB}}$			50		MHz

## Electrical Characteristics (continued)

( $f_{\text{Sample}} = 2\text{MSPS}$ ;  $V_{\text{AVDD}} = 5.0\text{V}$ ,  $V_{\text{OVDD}} = 1.8\text{V}$ ;  $V_{\text{REFIN/OUT}} = 2.5\text{V}$  (Internal Reference);  $T_A = T_{\text{MIN}}$  to  $T_{\text{MAX}}$  (Note 1). Typical values are at  $T_A = +25^\circ\text{C}$ , unless otherwise noted.)

PARAMETER	SYMBOL	CONDITIONS	MIN	TYP	MAX	UNITS
<b>POWER SUPPLIES</b>						
Analog Supply Voltage	AVDD		3.0	5.0	5.25	V
Interface Supply Voltage	OVDD		1.7		3.6	V
Analog Supply Current	I(AVDD)			5.5	7	mA
Interface Supply Current	I(OVDD)	DOUT load: $C_{\text{LOAD}} = 10\text{pF}$		0.75	1	mA
Analog Standby Current	$I_S(\text{AVDD})$	(Note 3)		1		mA
Interface Standby Current	$I_S(\text{OVDD})$	(Note 3)		1		$\mu\text{A}$
<b>DIGITAL INPUTS</b>						
Input Voltage High	$V_{\text{IH}}$		0.8 x $V_{\text{OVDD}}$			V
Input Voltage Low	$V_{\text{IL}}$				0.2 x $V_{\text{OVDD}}$	V
Input Capacitance			2			pF
Input Leakage			1			$\mu\text{A}$
<b>DIGITAL OUTPUTS</b>						
Output Voltage High	$V_{\text{OH}}$	$I_{\text{SOURCE}} = 2\text{mA}$	$V_{\text{OVDD}} - 0.4$			V
Output Voltage Low	$V_{\text{OL}}$	$I_{\text{SINK}} = 2\text{mA}$			$V_{\text{OGND}} + 0.4$	V
<b>TIMING</b>						
Conversion Period	$t_1$		500			ns
SCLK to DOUT Hold	$t_2$		1			ns
SCLK to DOUT Valid	$t_3$		14			ns
SCLK High	$t_4$		8			ns
SCLK Period	$t_5$		20			ns
SCLK low	$t_6$		8			ns
$\overline{\text{CNVST}}$ Rising Edge to SCLK Rising Edge	$t_7$		5			ns
SCLK Rising Edge to $\overline{\text{CNVST}}$ Rising Edge	$t_8$		5			ns
$\overline{\text{CNVST}}$ High	$t_9$		60			ns
$\overline{\text{CNVST}}$ Falling Edge to SCLK Rising Edge	$t_{10}$		10			ns
SCLK Falling Edge to $\overline{\text{CNVST}}$ Falling Edge	$t_{11}$		0			ns
$\overline{\text{CNVST}}$ Low Time for Valid Sample	$t_{12}$		400			ns

**Note 1:** Units are 100% production tested at  $T_A = +25^\circ\text{C}$  and are guaranteed by design and characterization from  $T_A = T_{\text{MIN}}$  to  $T_{\text{MAX}}$ .

**Note 2:** Exclude the reference drift and offset error.

**Note 3:** This current is drawn when the device has completed conversion and SCLK is idle.

Typical Operating Characteristics

( $f_{SAMPLE} = 2\text{Mps}$ ;  $V_{AVDD} = 5.0\text{V}$ ,  $V_{OVDD} = 1.8\text{V}$ ;  $V_{REFIN/OUT} = 2.5\text{V}$  (Internal Reference);  $T_A = T_{MIN}$  to  $T_{MAX}$ . Typical values are at  $T_A = +25^\circ\text{C}$ , unless otherwise noted.)

OFFSET AND GAIN ERROR vs. TEMPERATURE (CHANNEL A)

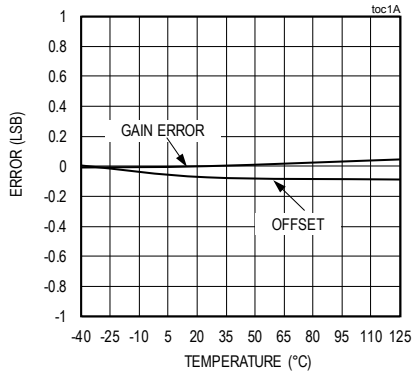

OFFSET AND GAIN ERROR vs. TEMPERATURE (CHANNEL B)

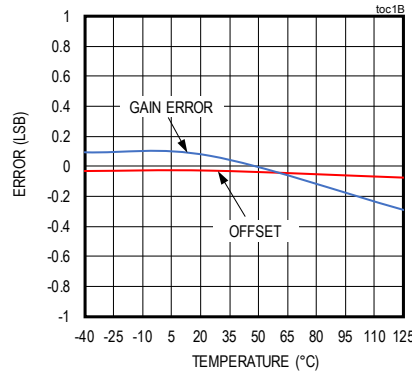

OFFSET AND GAIN ERROR vs. SUPPLY VOLTAGE (CHANNEL A)

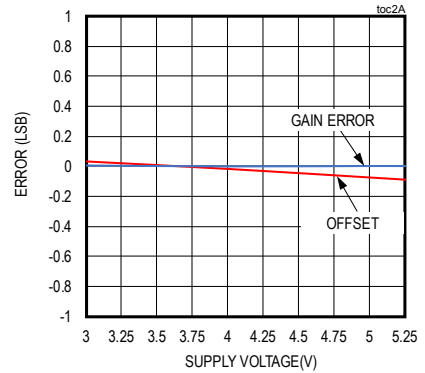

OFFSET AND GAIN ERROR vs. SUPPLY VOLTAGE (CHANNEL B)

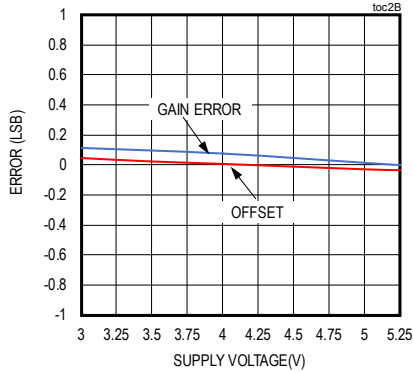

OFFSET AND GAIN ERROR vs. REFERENCE VOLTAGE (CHANNEL A)

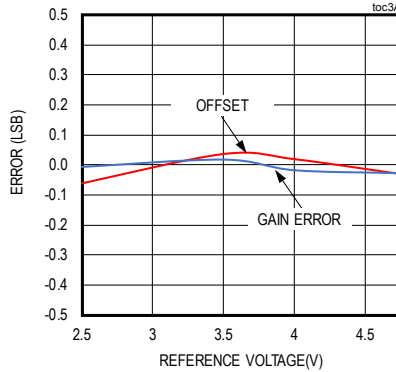

OFFSET AND GAIN ERROR vs. REFERENCE VOLTAGE (CHANNEL B)

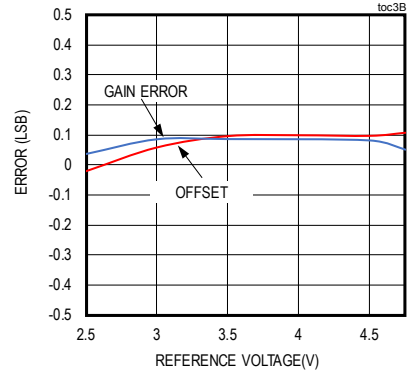

OUTPUT NOISE HISTOGRAM (CHANNEL A)

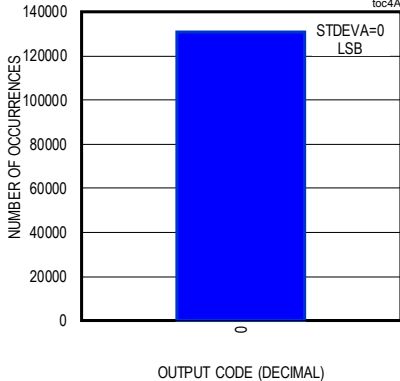

OUTPUT NOISE HISTOGRAM (CHANNEL B)

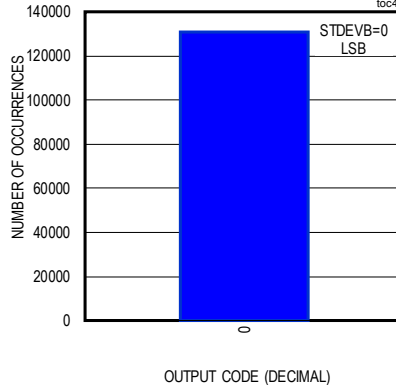

DNL vs. CODE (CHANNEL A)

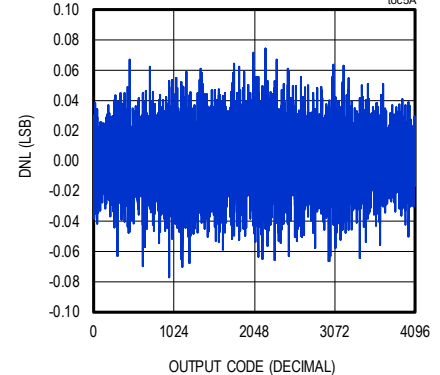

Typical Operating Characteristics (continued)

( $f_{SAMPLE} = 2\text{MSPS}$ ;  $V_{AVDD} = 5.0\text{V}$ ,  $V_{OVDD} = 1.8\text{V}$ ;  $V_{REFIN/OUT} = 2.5\text{V}$  (Internal Reference);  $T_A = T_{MIN}$  to  $T_{MAX}$ . Typical values are at  $T_A = +25^\circ\text{C}$ , unless otherwise noted.)

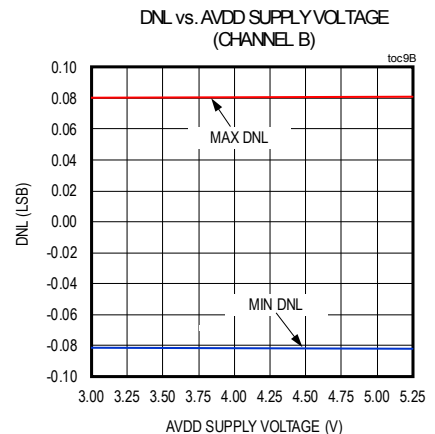
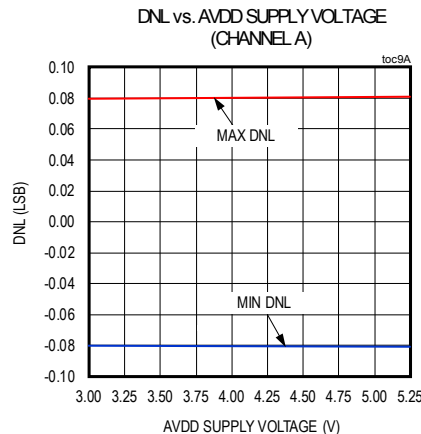
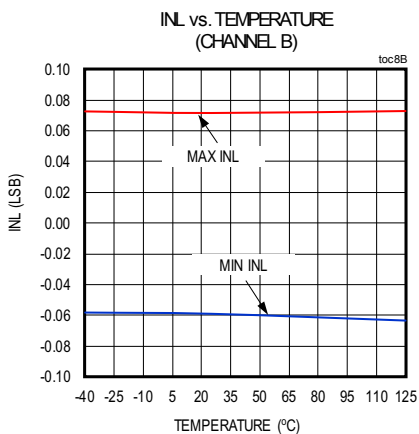
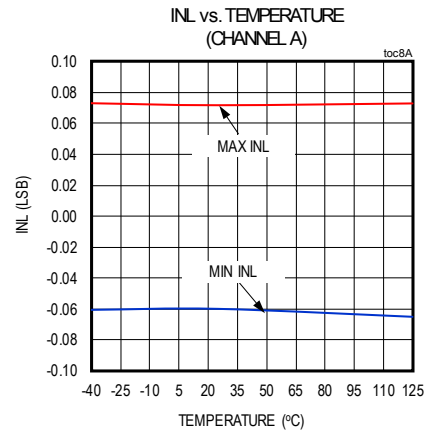
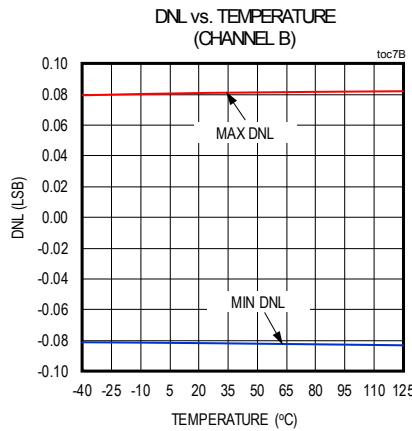
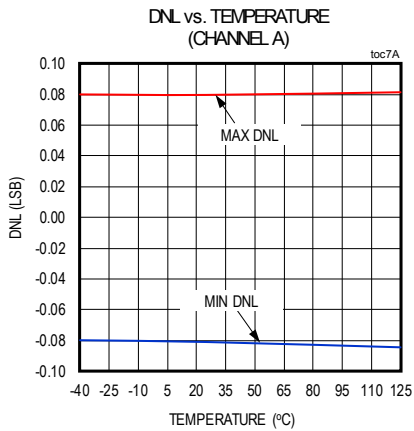
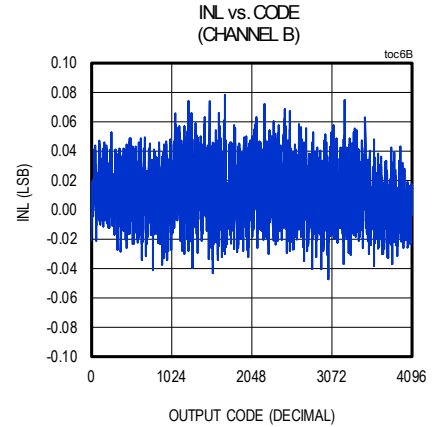
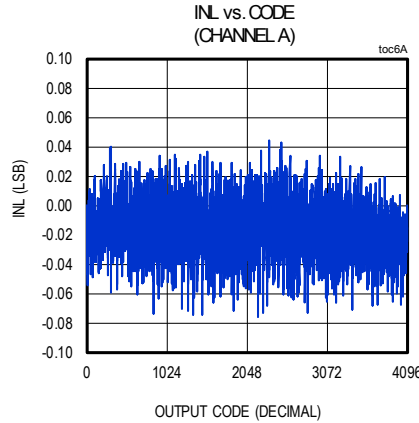
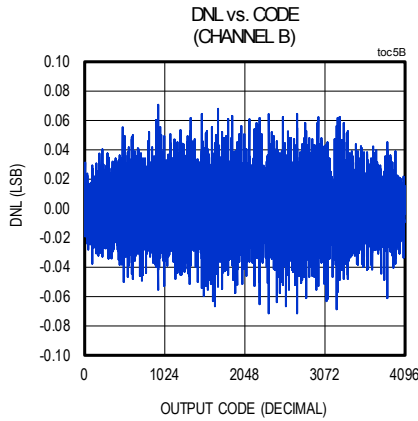

Typical Operating Characteristics (continued)

( $f_{SAMPLE} = 2\text{Mps}$ ;  $V_{AVDD} = 5.0\text{V}$ ,  $V_{OVDD} = 1.8\text{V}$ ;  $V_{REFIN/OUT} = 2.5\text{V}$  (Internal Reference);  $T_A = T_{MIN}$  to  $T_{MAX}$ . Typical values are at  $T_A = +25^\circ\text{C}$ , unless otherwise noted.)

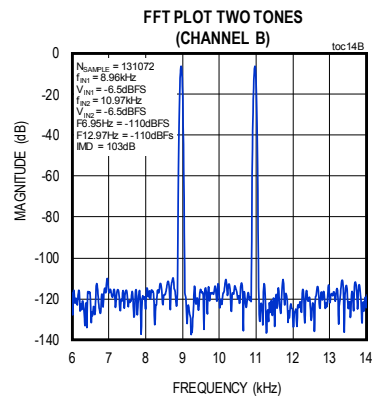
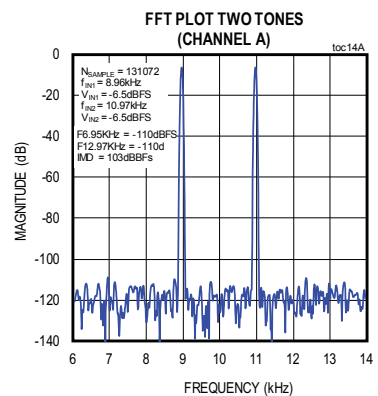
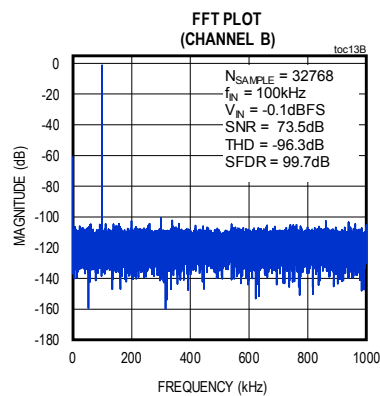
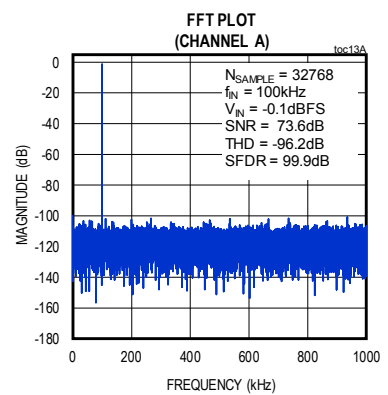
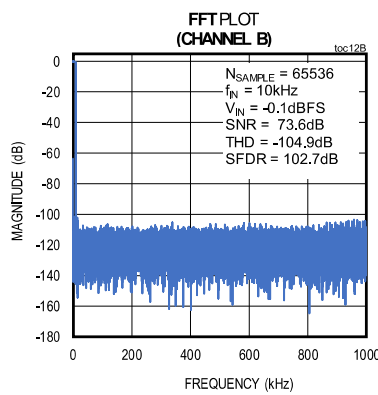
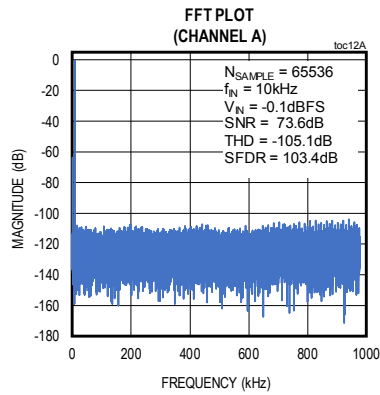
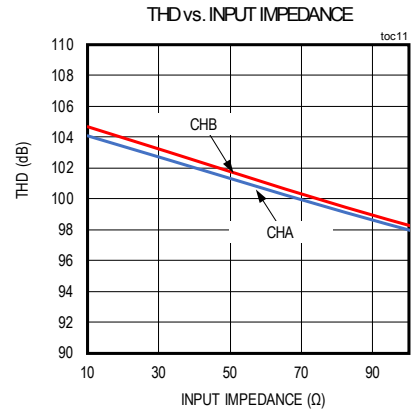
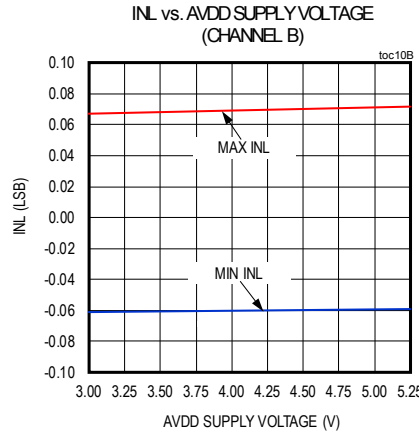
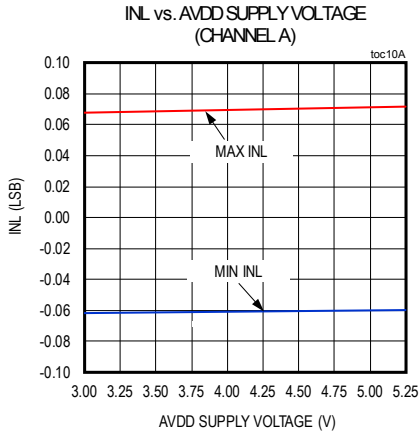

Typical Operating Characteristics (continued)

( $f_{SAMPLE} = 2\text{Mps}$ ;  $V_{AVDD} = 5.0\text{V}$ ,  $V_{OVDD} = 1.8\text{V}$ ;  $V_{REFIN/OUT} = 2.5\text{V}$  (Internal Reference);  $T_A = T_{MIN}$  to  $T_{MAX}$ . Typical values are at  $T_A = +25^\circ\text{C}$ , unless otherwise noted.)

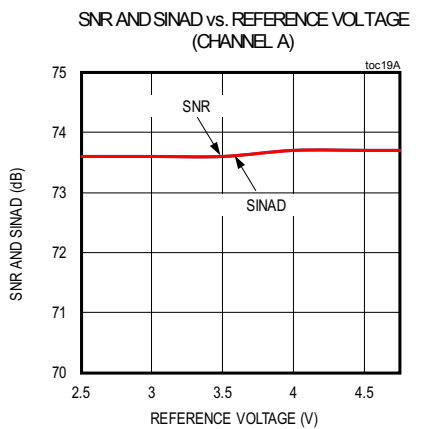
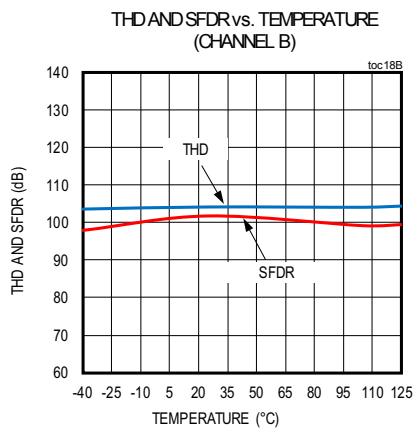
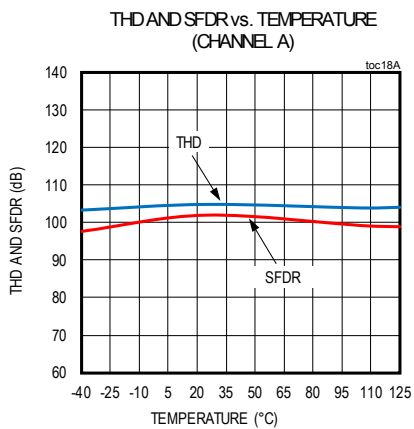
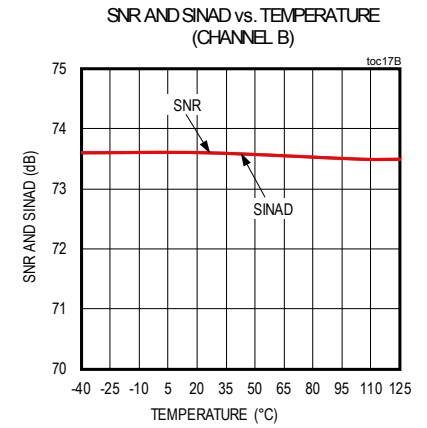
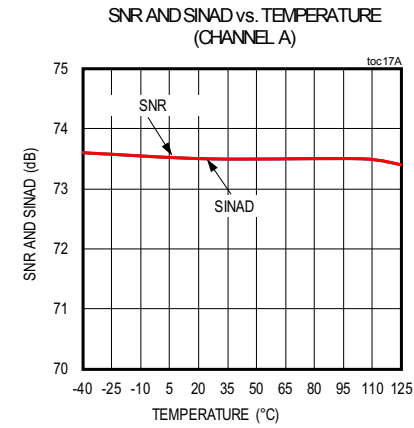
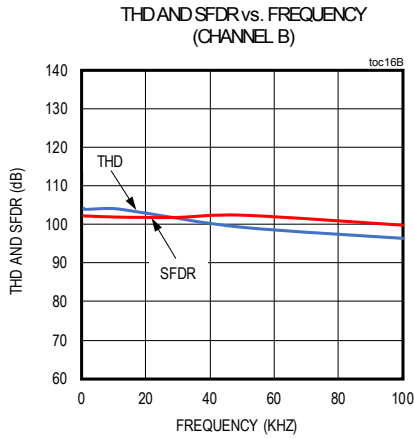
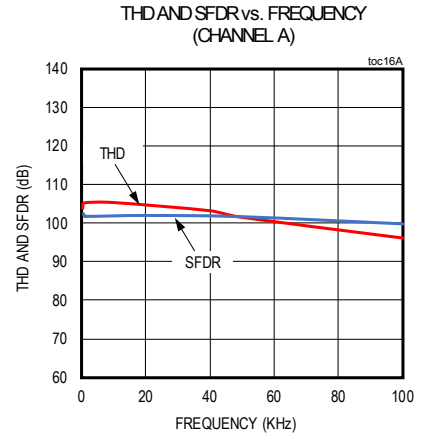
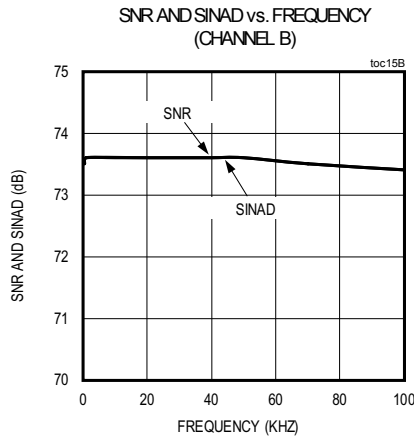
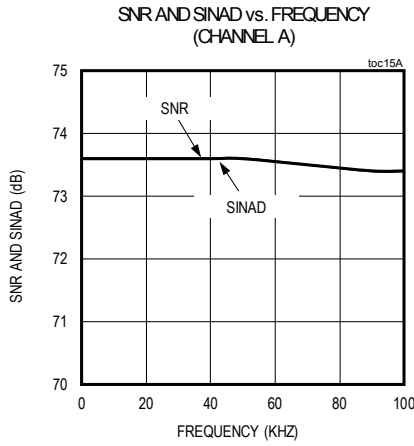



Typical Operating Characteristics (continued)

( $f_{SAMPLE} = 2\text{MSPS}$ ;  $V_{AVDD} = 5.0\text{V}$ ,  $V_{OVDD} = 1.8\text{V}$ ;  $V_{REFIN/OUT} = 2.5\text{V}$  (Internal Reference);  $T_A = T_{MIN}$  to  $T_{MAX}$ . Typical values are at  $T_A = +25^\circ\text{C}$ , unless otherwise noted.)

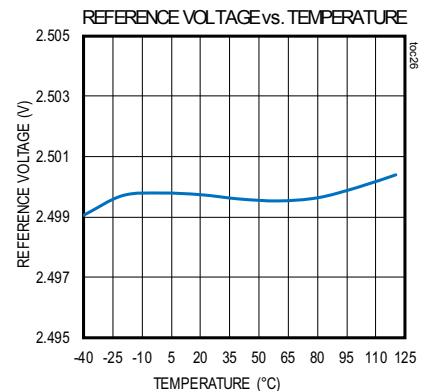
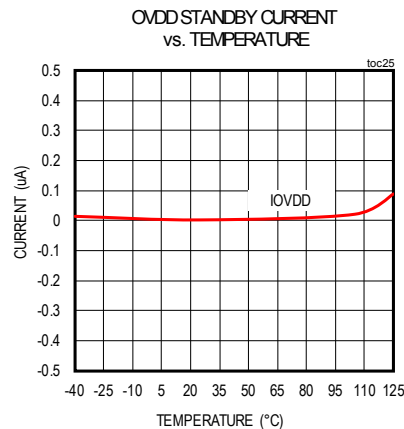
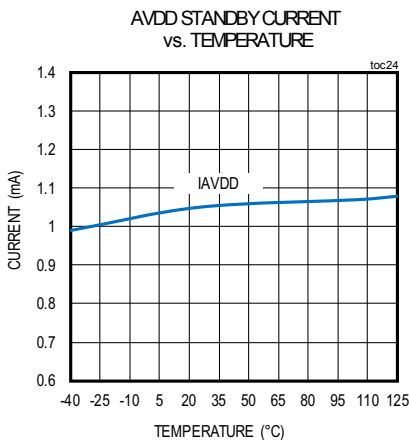
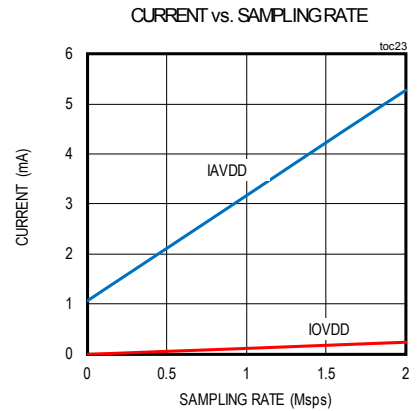
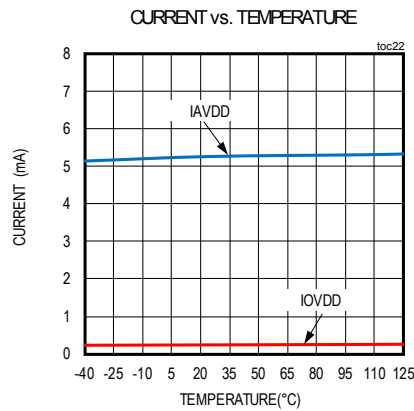
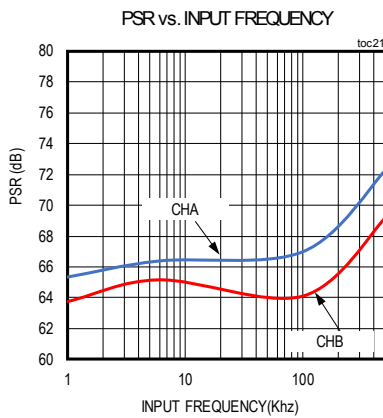
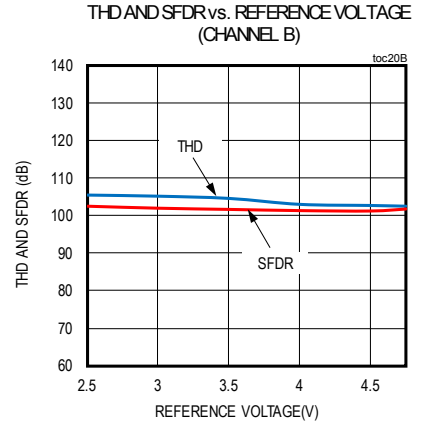
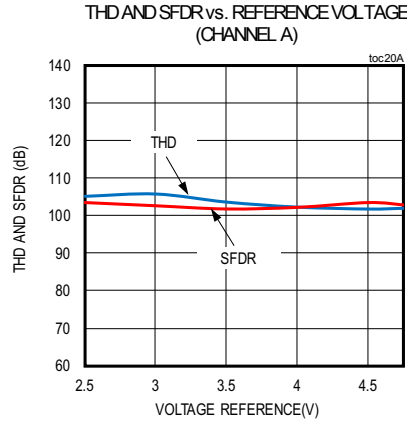
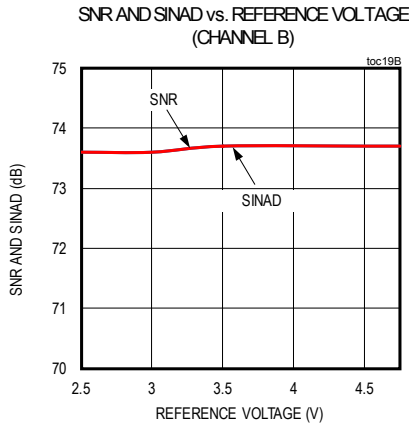

Pin Configuration

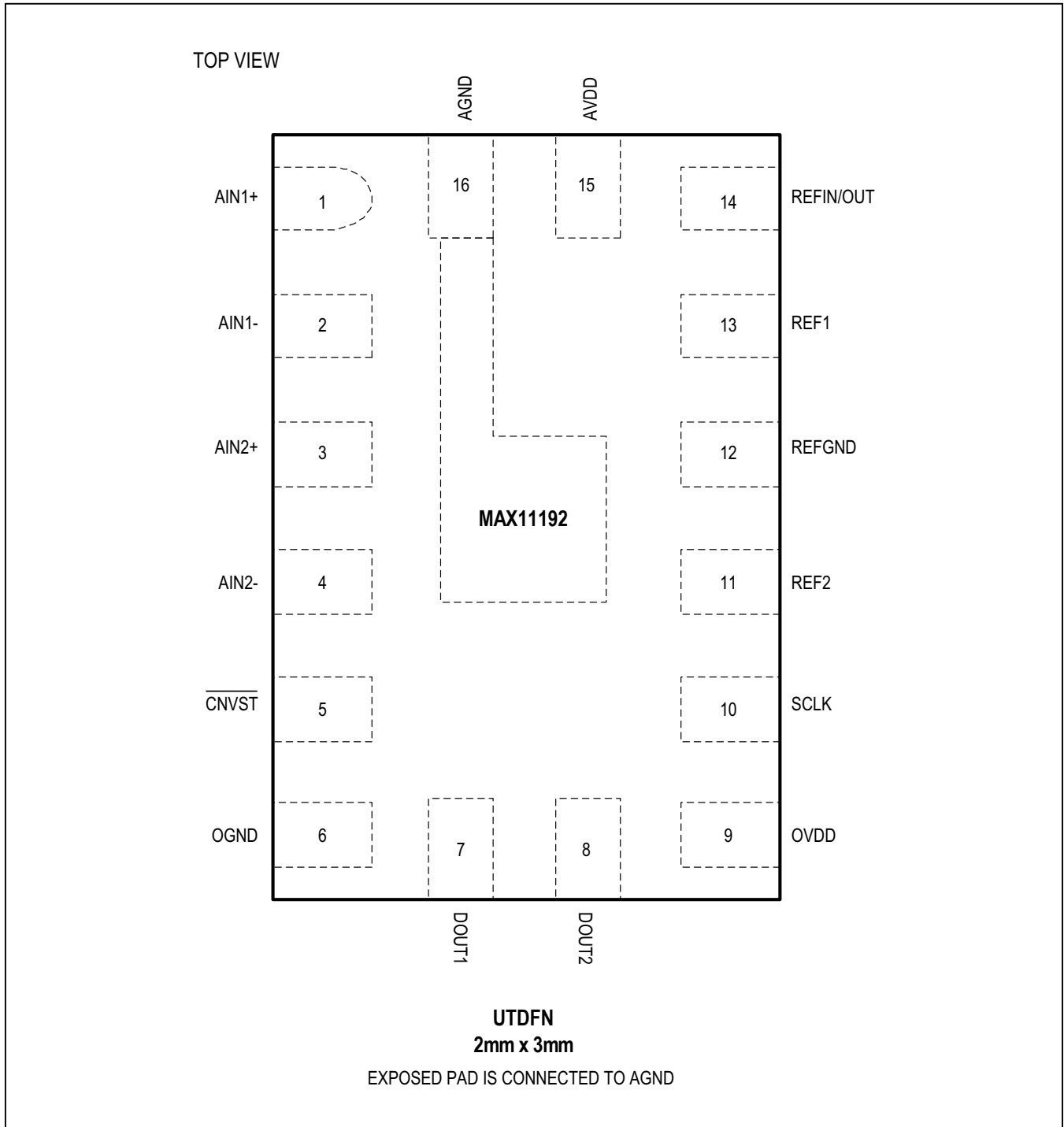

Pin Description

PIN	NAME	FUNCTION
1	AIN1+	ADC1 Positive (+) Analog Input
2	AIN1-	ADC1 Negative (-) Analog Input
3	AIN2+	ADC2 Positive (+) Analog Input
4	AIN2-	ADC2 Negative (-) Analog Input
5	$\overline{\text{CNVST}}$	Conversion Start Input
6	OGND	Ground (IO Ground)
7	DOUT1	Serial Interface Data Out for ADC1
8	DOUT2	Serial Interface Data Out for ADC2
9	OVDD	IO Supply. Bypass with a 10 $\mu$ F capacitor to ground
10	SCLK	Serial Interface Clock
11	REF2	REF2 Bypass Pin. Bypass with a 1 $\mu$ F capacitor to ground
12	REFGND	Ground (Reference Ground)
13	REF1	REF1 Bypass Pin. Bypass with a 1 $\mu$ F capacitor to ground
14	REFIN/OUT	External Reference Input or Internal Reference Decoupling. Bypass with 1 $\mu$ F capacitor to ground
15	AVDD	Analog Supply Pin. Bypass with a 10 $\mu$ F capacitor to ground
16	AGND	Ground

Functional Diagram

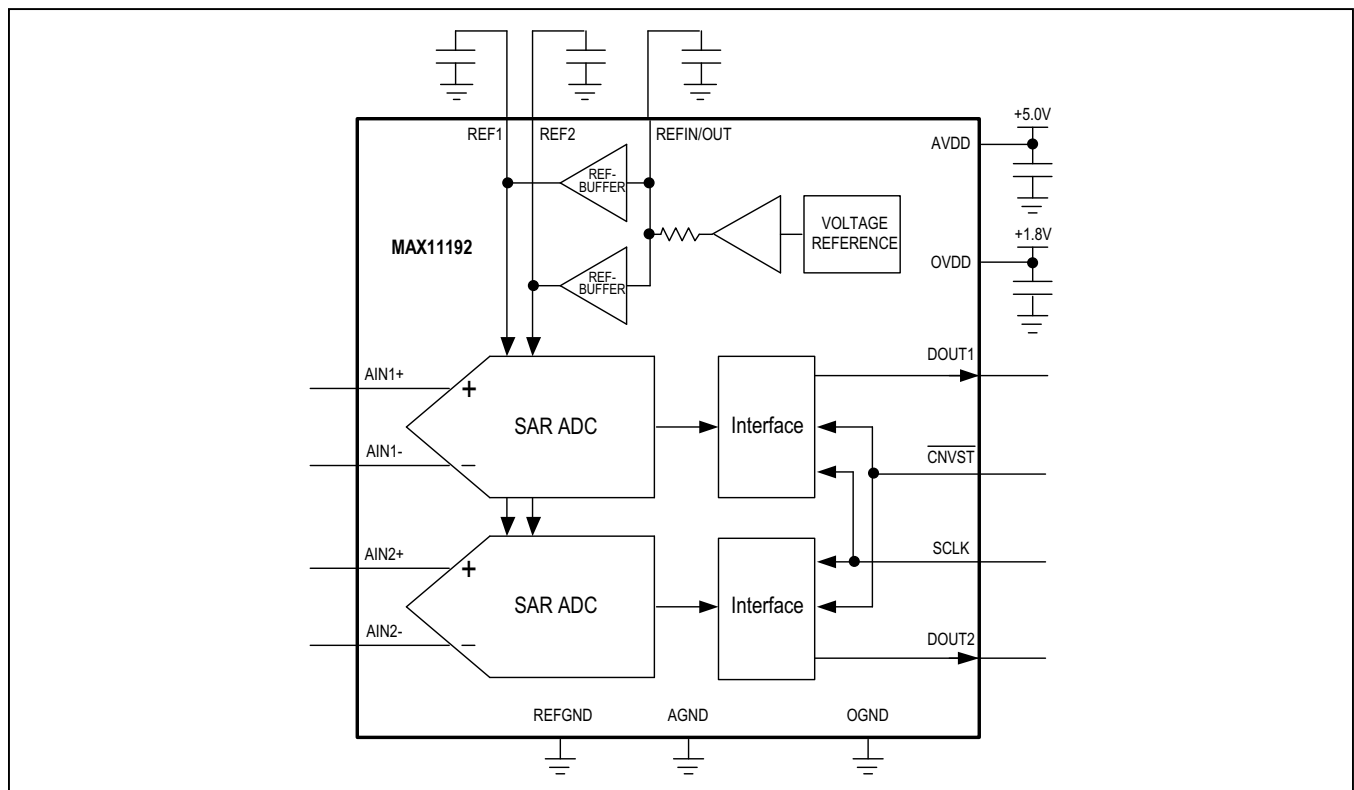

**Detailed Description**

The MAX11192 is a 12-bit, 2-channel, 2Msps, SAR ADC with simultaneous sampling, balanced differential inputs, and a separate data output for each channel. This ADC features best-in-class sample rate and resolution in a tiny 2mm x 3mm package. An integrated voltage reference and reference buffers help to minimize board space, component count, and system cost. An internal oscillator sets conversion time, thereby simplifying external timing requirements.

For fast throughput, the SPI-compatible digital interface includes two data out pins (DOUT1 and DOUT2). DOUT1 provides conversion data from ADC1, while DOUT2 provides conversion data from ADC2. Data bits are clocked out on the rising edge of SCLK.

**Analog Inputs**

The analog inputs of the MAX11192, AINn+ and AINn-, should be driven with balanced differential signals. The input signals can range from 0V to VREF. Thus, the differential input interval VDIFF = (AINn+) - (AINn-) ranges from -VREF to +VREF, and the full-scale range is:

$$FSR = 2 \times V_{REF}$$

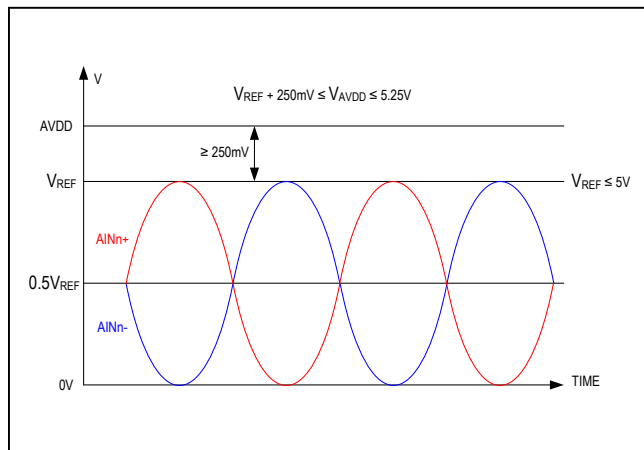

Figure 1. Input Signal Ranges

The nominal resolution step width of the least significant bit (LSB) is:

$$LSB = \frac{FSR}{2^N} = \frac{2 \times V_{REF}}{2^N}, N = 12$$

The differential analog input must be centered with respect to a common mode signal of VREF/2, with a tolerance of ±100mV. The reference voltage can range from 2.5V to 250mV below the reference supply AVDD. This will guarantee adequate headroom for the internal reference buffers. Figure 1 illustrates signal ranges for AINn+/AINn-, reference voltage VREF and reference supply voltage AVDD.

Figure 2 shows the analog input equivalent circuit of MAX11192. The ADC samples both inputs, AINn+ and AINn-, with a differential on-chip track-and-hold exhibiting no pipeline delay or latency.

Each analog input (see Figure 2) has dedicated input clamps to protect from overranging. Diodes D1 and D2 provide ESD protection and act as a clamp for the input voltages. Diodes D1/D2 can sustain a maximum forward current of 100mA. The sampling switches connect the inputs to the sampling capacitors.

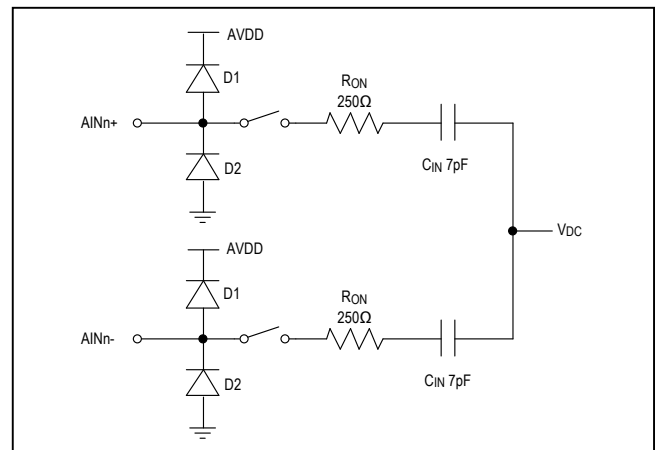

Figure 2. Simplified Model of Input Sampling Circuit

**Input Settling**

Figure 3 shows the timing of the conversion cycle's track, SAR conversion, and read data operations. In the track phase, starting with the rising edge of  $\overline{CNVST}$ , the sample switches are closed and the analog inputs are directly connected to the sample capacitors. The source resistance determines the charging of the sample capacitor to the input voltage. The falling edge of  $\overline{CNVST}$  is the sampling instant for the ADCs. At this instant, the track phase ends, the sample switches open, and the ADC enters into the successive approximation (SAR) conversion phase. In the conversion phase, a comparator compares the voltage on the sample capacitor against the internal DAC value, which cycles through values of binary-weighted fractions of  $V_{REF}$  using the successive approximation technique. The final result is read through the SPI bus. Note that ADC1 and ADC2 operate in parallel and conversion data is available simultaneously through DOUT1 and DOUT2.

The ADCs go back into track phase on the rising edge of  $\overline{CNVST}$ . To achieve accurate conversion results, each ADC should track its input signal for an interval longer than the input signal's settling time. If the signal cannot settle within the allocated track time due to excessive source resistance, external ADC drivers are recommended to achieve faster settling. Note that, since the MAX11192 has a fixed conversion time set by an internal oscillator, reducing the sample rate can increase the track time.

The settling behavior is determined by the time constant in the sampling network. The time constant depends upon the total resistance (source resistance + switch resistance,  $R_{ON}$ ) and total capacitance (sampling capacitor  $C_{IN}$ , external input capacitor, PCB parasitic capacitors,

etc). Modeling the input circuit with a single pole network, the time constant,  $R_{TOTAL} \times C_{LOAD}$ , of the input should not exceed  $t_{TRACK}/12$ , where  $R_{TOTAL}$  is the total resistance (source resistance + switch resistance),  $C_{LOAD}$  is the total capacitance (sampling capacitor, external input capacitor, PCB parasitic capacitor), and  $t_{TRACK}$  is the track time.

When an ADC driver amplifier is used, it is recommended to use a series resistance (typically  $5\Omega$  to  $50\Omega$ ) between the amplifier and the ADC inputs, as shown in the Application Diagram. The following are some of the requirements for the ADC driver amplifier.

- 1) Fast settling time: For a multichannel multiplexed circuit, the ADC driver amplifier must be able to settle with an error less than 0.5 LSB during the minimum track time when a full-scale step is applied.
- 2) Low noise: It is important to ensure that the ADC driver has a sufficiently low noise density in the bandwidth of interest. When the MAX11192 is used with its full bandwidth of 50MHz, it is preferable to use an amplifier with an output noise spectral density of less than  $6nV/\sqrt{Hz}$ , to ensure that the overall SNR is not degraded significantly. It is recommended to insert an external RC filter at the ADC input to attenuate out-of-band input noise.
- 3) To take full advantage of the ADC's excellent dynamic performance, we recommend the use of ADC drivers with equal or even better THD performance. This will ensure that the ADC drivers do not limit distortion performance in the signal path. The ADC drivers listed in Table 1 are all excellent choices.

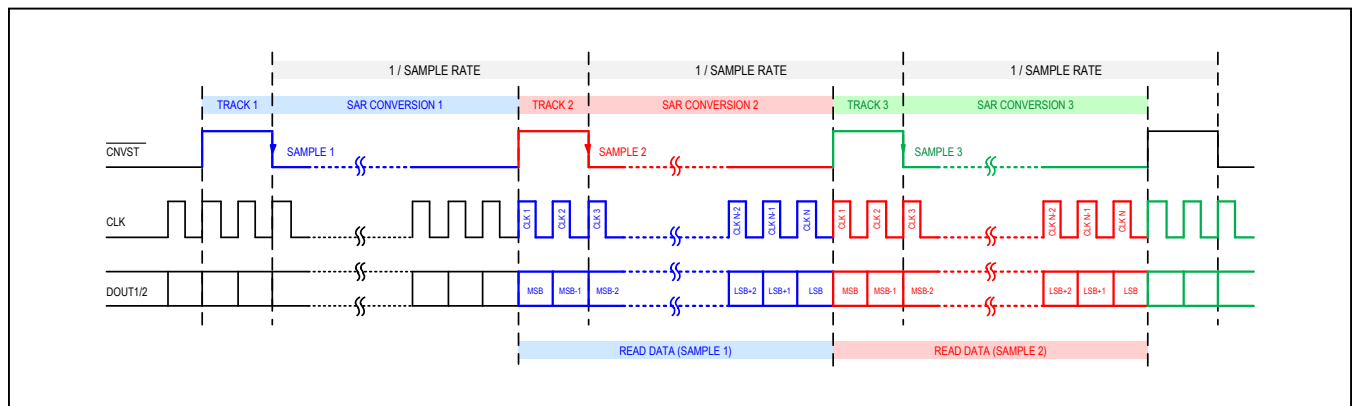

Figure 3. Conversion Timing: Track, SAR Conversion, and Read Operations

**Table 1. ADC Driver Amplifier Recommendations**

AMPLIFIER	INPUT-NOISE DENSITY (NV/√Hz)	SMALL-SIGNAL BANDWIDTH (MHZ)	SLEW RATE (V/MS)	THD (DB)	ICC (MA)	MAX OFFSET (MV)	COMMENTS
MAX44263	12.7	15	7	-110	0.75	0.05	Low current, low THD at 10kHz
MAX44242	5	10	8	-124	1.2	0.6	High voltage 2.7V to 20V, low THD at 1kHz
MAX9632	1	55	30	-128	3.9	0.125	Low noise, low THD at 10kHz

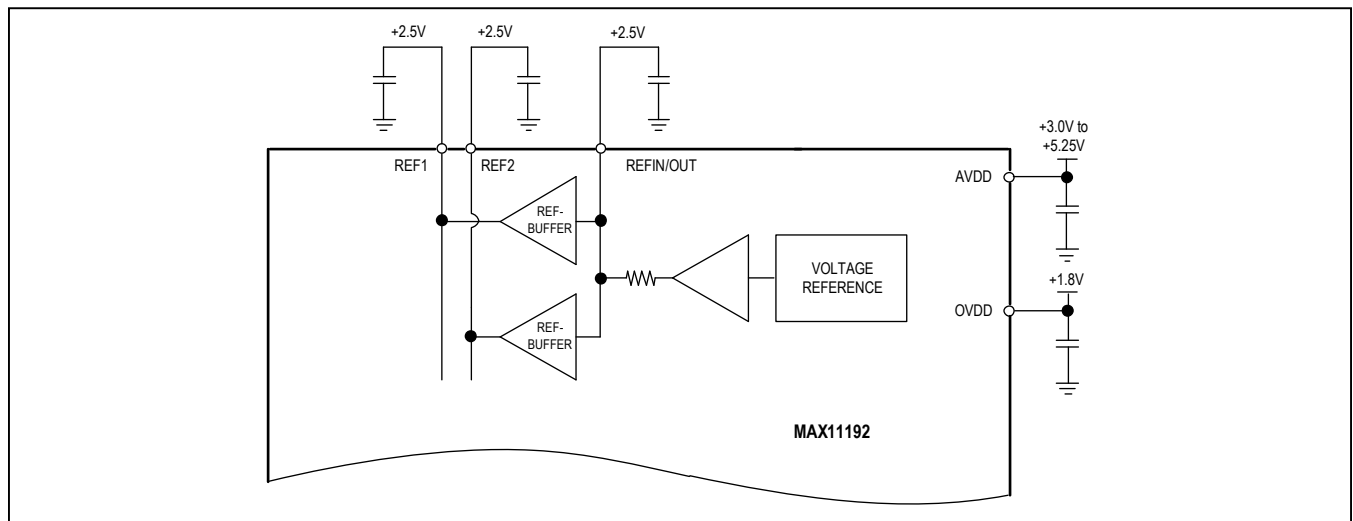

Figure 4. Internal Reference

**Input Filtering**

Noisy input signals should be filtered prior to the ADC driver amplifier input with an appropriate filter to minimize noise. The RC network shown in the Application Diagram is mainly designed to reduce the load transient seen by the amplifier when the ADC starts the track phase. This network has to satisfy the settling time requirement and provides the benefit of limiting the noise bandwidth.

**Voltage Reference Configurations**

**Using An Internal Reference**

The MAX11192 features a 2.5V integrated reference with built-in reference buffers that help to reduce component count and board space. When using internal reference, only bypass capacitors are required on the REF1, REF2,

and REFIN/OUT pins (see Figure 4). The REF1/REF2 pins require external bypass capacitors of at least 1µF.

**Using An External Reference**

To use an external reference (see Figure 5), drive the REFIN/OUT pin directly with an external reference voltage source, ensuring that the reference voltage is no greater than AVDD - 250mV. This will allow the on-chip reference buffers to operate with sufficient supply head-room. The REF1/REF2 pins require external bypass capacitors of at least 1µF.

Table 2 lists excellent choices for low-noise, low-temperature drift external references.

**Transfer Function**

Figure 6 shows the ideal transfer characteristics for the MAX11192.

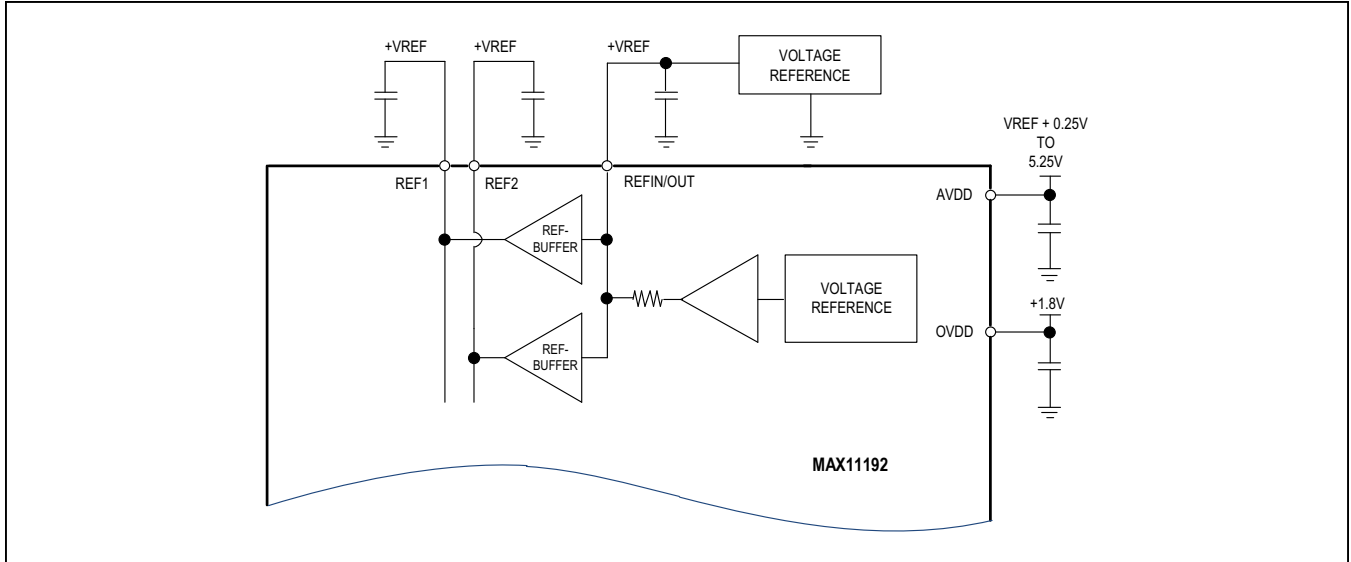

Figure 5. External Reference

Table 2. External Reference Recommendations

REFERENCE	INITIAL ACCURACY (%)	TEMPERATURE DRIFT MAX (PPM/°C)	NOISE (MVP-P)	COMMENTS
MAX6070	±0.04	15	7	Low noise
MAX6133	±0.04	3	16	Very low drift
MAX6072	±0.04	6	9	Dual reference

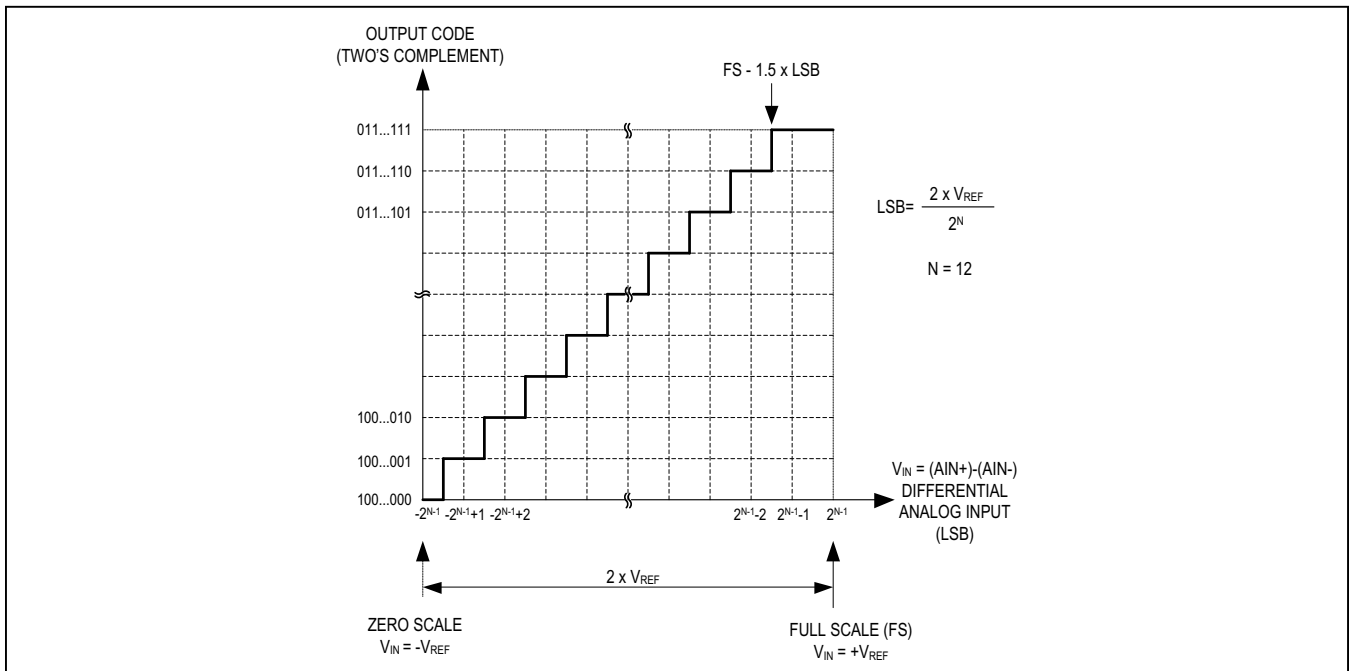

Figure 6. Ideal ADC Transfer Characteristics

**Digital Interface**

Conversion data may be read in the track phase, the conversion phase, or both. Outlined below are the specifics of the various ways to read conversion data.

The input signals of the two ADC channels are sampled simultaneously on the falling edge of  $\overline{CNVST}$  and the conversion is initiated. At the end of the conversion, the ADCs go idle until the next rising edge of  $\overline{CNVST}$ , at which point

the ADCs enter track mode. To complete a conversion, the time between  $\overline{CNVST}$  falling and rising edge must be at least the minimum of the conversion time  $t_{12}$  (see Figure 11). The conversion data can then be read immediately after the rising edge of the next  $\overline{CNVST}$  pulse, which should not occur before the minimum conversion time value ( $t_{12}$ ) has elapsed. guard against digital noise from the data bus, corrupting the sample.

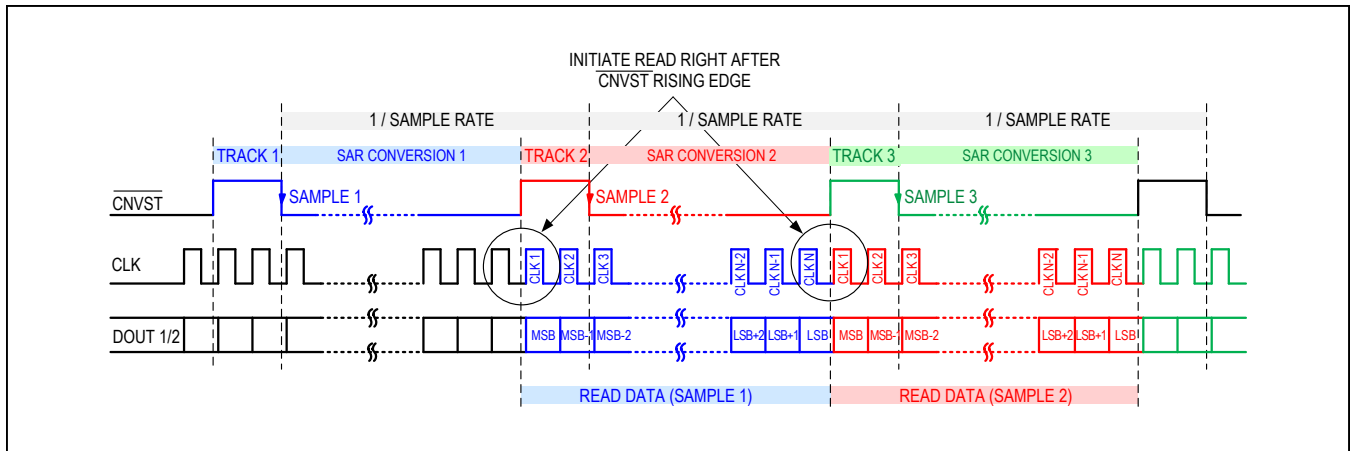

Figure 7. Convert and Data Read MAX11192

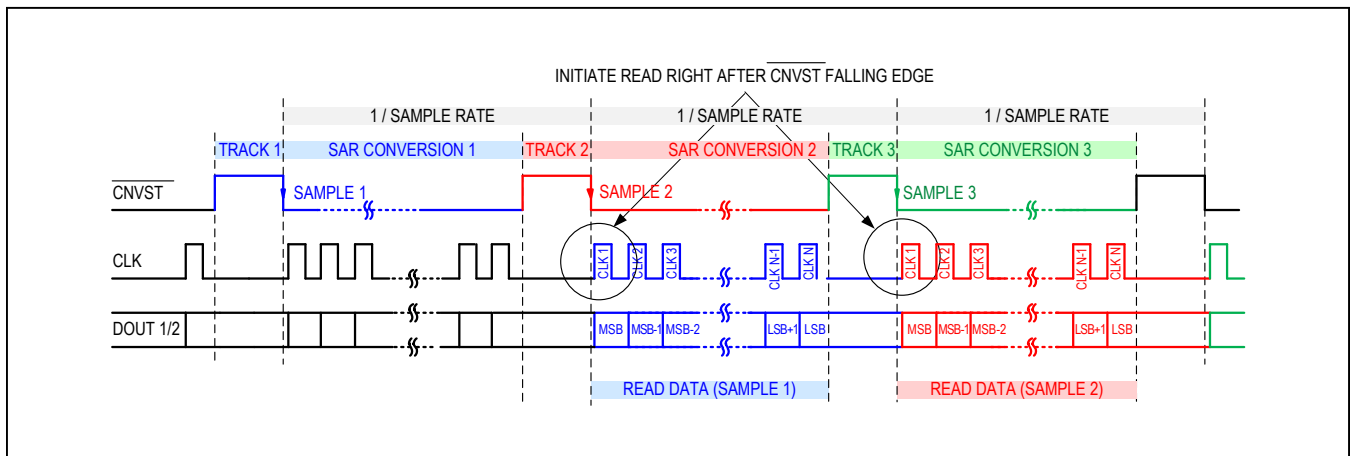

Figure 8. Reading Data After Falling Edge of CNVST



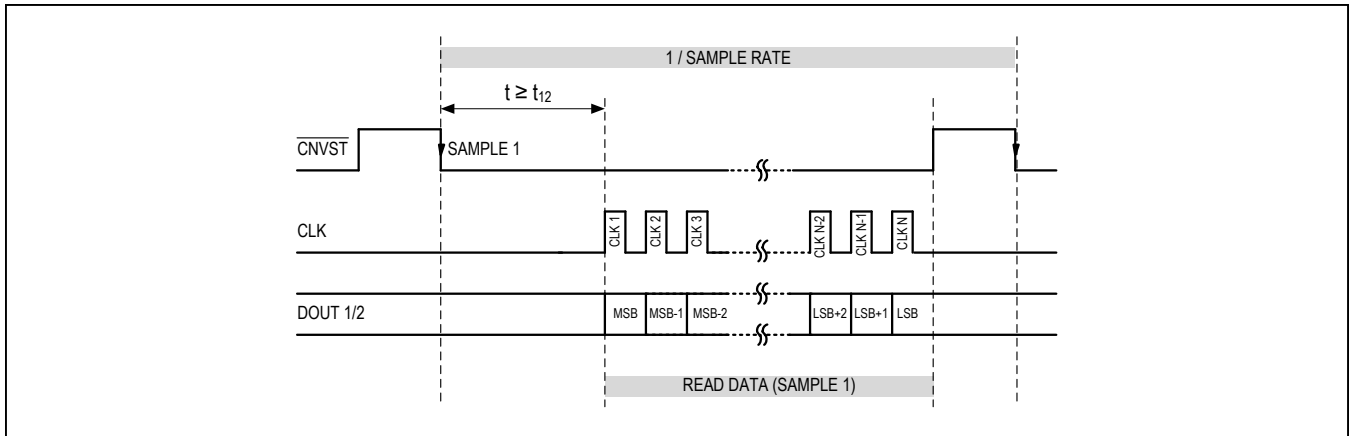

Figure 9. Convert and Data Read in a Single Conversion Period

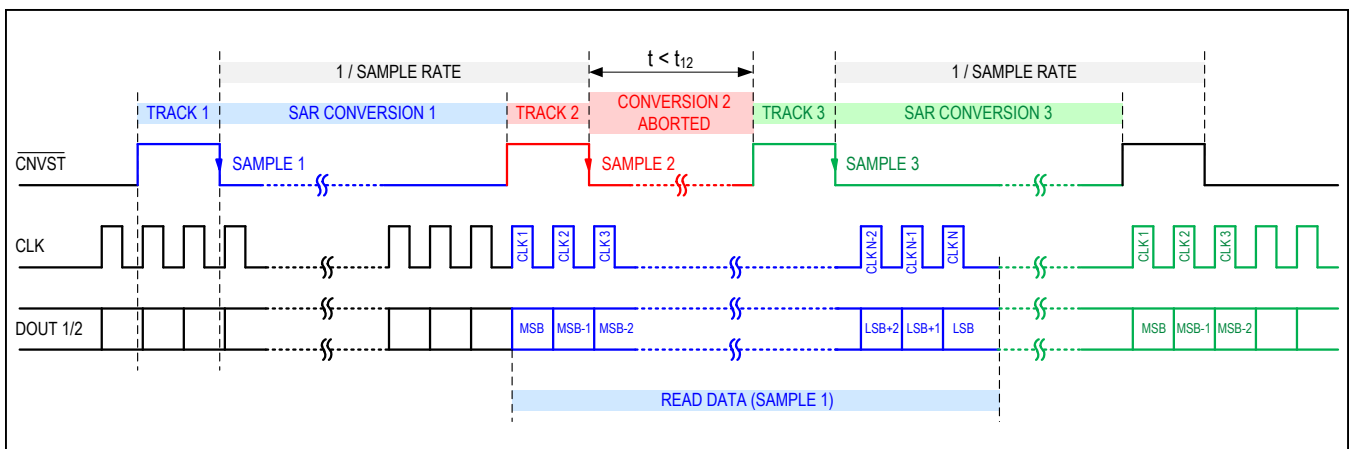

Figure 10. Conversion Abort Data Read

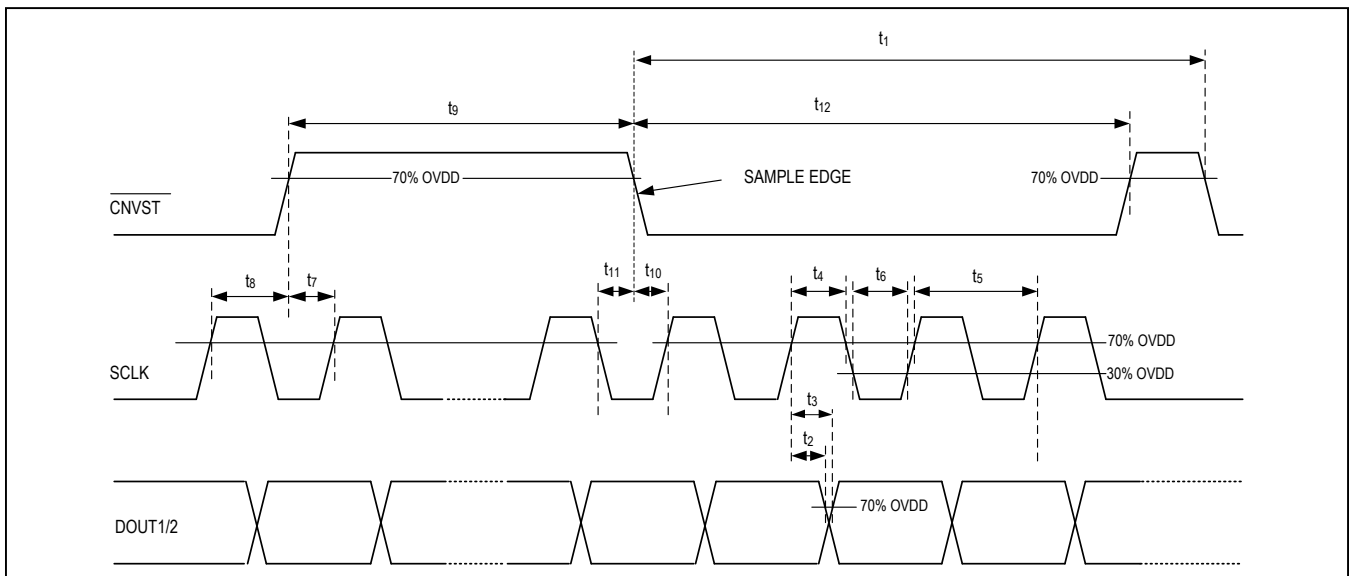

Figure 11. Interface Timing Specifications

**Applications Information**

**Interfacing to Common Input Signals**

Real-world signals typically require conditioning before they can be digitized by an ADC. The following outlines common examples of analog signal processing circuits.

The ADCs in the MAX11192 accept differential input signals with unipolar common mode. Refer to **THD vs. Input Impedance** to use buffers to minimize distortion. The three following examples show input signal conditioning approaches to common signal path configurations.

**Differential Unipolar Input**

The circuit in [Figure 12](#) shows how amplifiers can be configured to buffer a differential unipolar input signal.

**Single-Ended Unipolar Input**

The circuit in [Figure 13](#) shows how a single-ended, unipolar signal can interface with the MAX11192. This signal conditioning circuit transforms a 0V to +V<sub>REF</sub> single-ended input signal to a fully differential output signal with a signal peak-to-peak amplitude of 2 x V<sub>REF</sub> and common-mode voltage of V<sub>REF</sub>/2. In this case, the single-ended signal source drives the high-impedance input of the first amplifier. This amplifier drives the AIN1+ input, and the

second stage amplifier with a peak-to-peak amplitude of V<sub>REF</sub> and a common-mode output voltage of V<sub>REF</sub>/2. The second amplifier inverts this signal to generate AIN1-, the inverted version of AIN1+.

**Single-Ended Bipolar Input**

[Figure 14](#) shows a signal conditioning circuit that transforms a -2 x V<sub>REF</sub> to +2 x V<sub>REF</sub> single-ended bipolar input signal to a balanced differential output signal with a peak-to-peak amplitude of 2 x V<sub>REF</sub> and a common-mode voltage V<sub>REF</sub>/2.

The single-ended bipolar input signal drives the inverting input of the first amplifier. This amplifier inverts and adds an offset to the input signal. It also drives the AIN1- input and the second stage amplifier with a peak-to-peak amplitude of V<sub>REF</sub> and a common-mode output voltage of V<sub>REF</sub>/2. The second amplifier is also in inverting configuration and drives the AIN1+ input. This amplifier adds an offset to generate a signal with a peak-to-peak amplitude of V<sub>REF</sub> and a common-mode output voltage of V<sub>REF</sub>/2. The input impedance, seen by the signal source, is determined by the input resistor of the first-stage inverting amplifier. The input impedance must be chosen carefully based on the output impedance of the signal source.

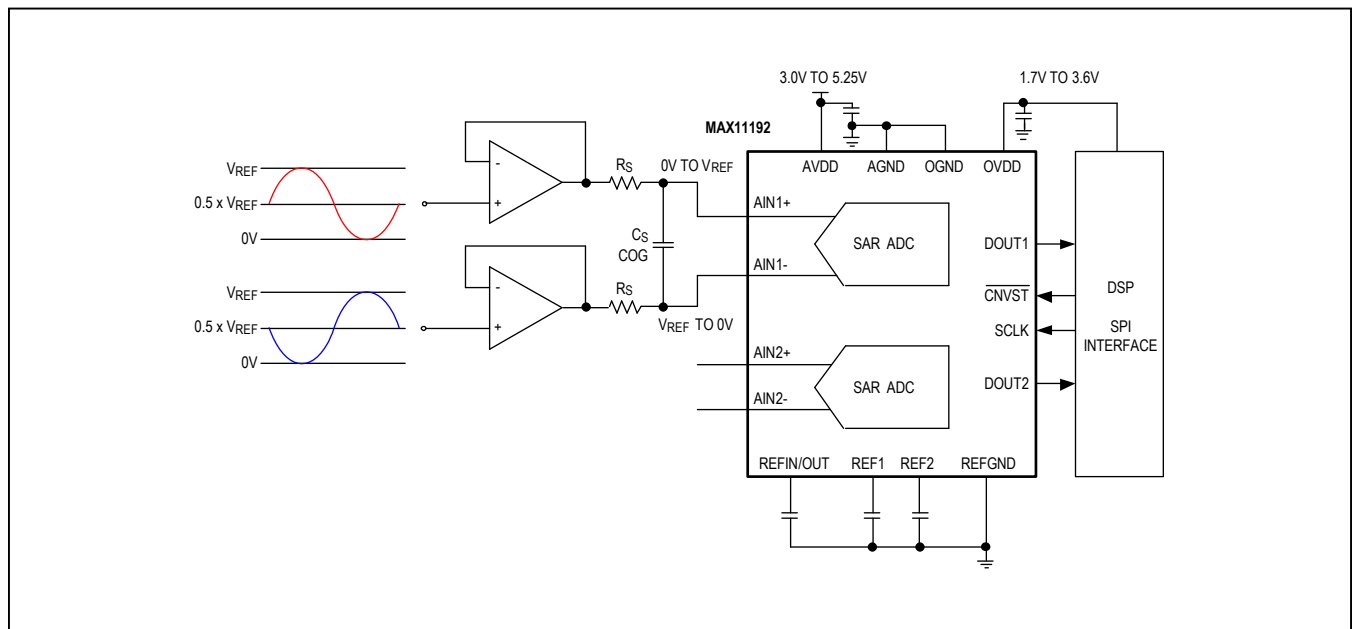

Figure 12. Unipolar Differential Input

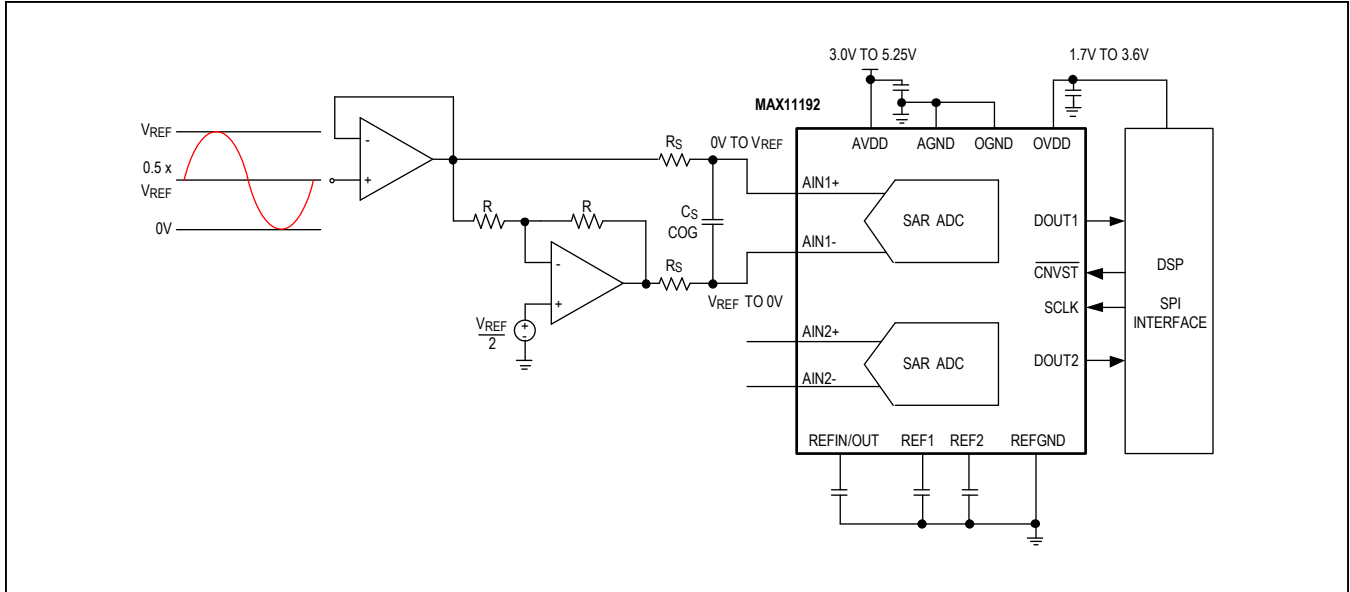

Figure 13. Unipolar Single-Ended Input

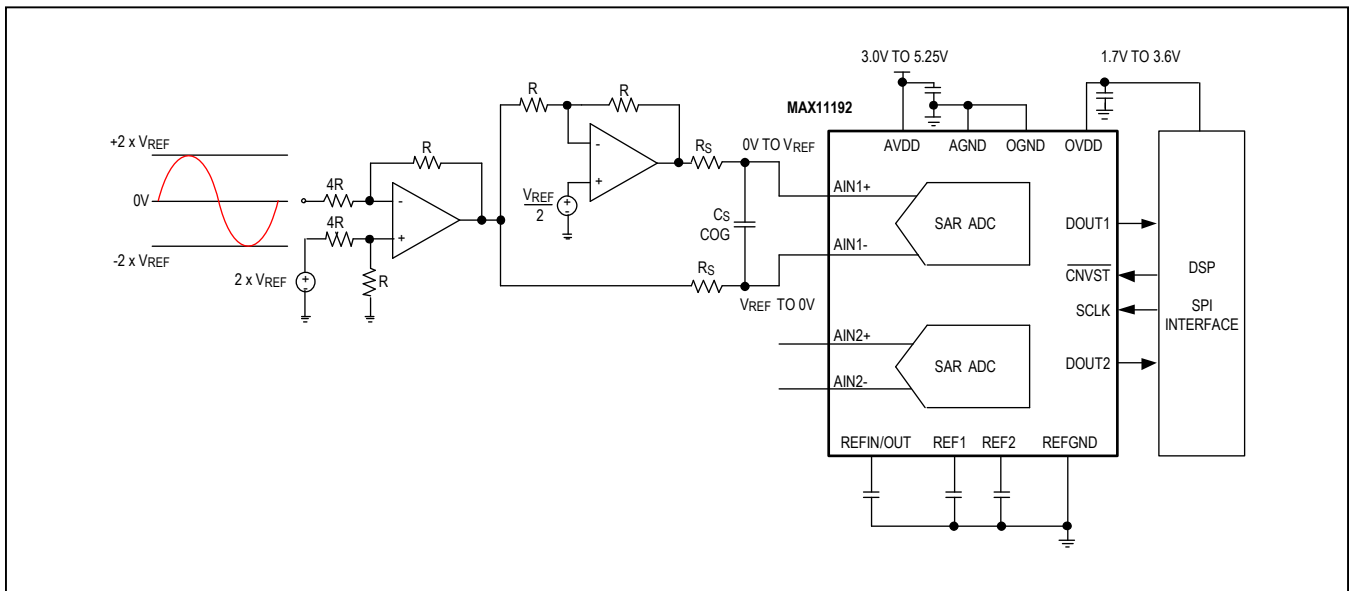

Figure 14. Bipolar Single-Ended Input

### Layout, Grounding, and Bypassing

For best performance, use PCBs with ground planes. Ensure that digital and analog signal lines are separated from each other. Do not run analog and digital lines parallel to one another (especially clock lines), and avoid running digital lines underneath the ADC package. A single solid GND plane configuration with digital signals routed from one direction and analog signals from the other provides the best performance. Connect the GND pins of the MAX11192 to this ground plane. Keep the ground return path to the power supply low impedance and as short as possible. A 1nF C0G ceramic chip capacitor should be placed between AINn+ and AINn- as close as possible to the MAX11192. This capacitor reduces the voltage tran-

sient seen by the driving stage of the ADC input. For best performance, connect the REF1/2 output to the ground plane with a 16V, 10 $\mu$ F ceramic chip capacitor with a X5R dielectric in a 1210 or smaller case size. Ensure that all bypass capacitors are connected directly into the ground plane with an independent via.

Bypass AVDD and OVDD to the ground plane with 10 $\mu$ F ceramic chip capacitors on each pin as close as possible to the device to minimize parasitic inductance. For best performance, bring the AVDD power plane in from the analog interface side of the MAX11192 and the OVDD power plane from the digital interface side of the device. [Figure 15](#) shows the PCB top layer of a sample layout with optimal placement of passive components.

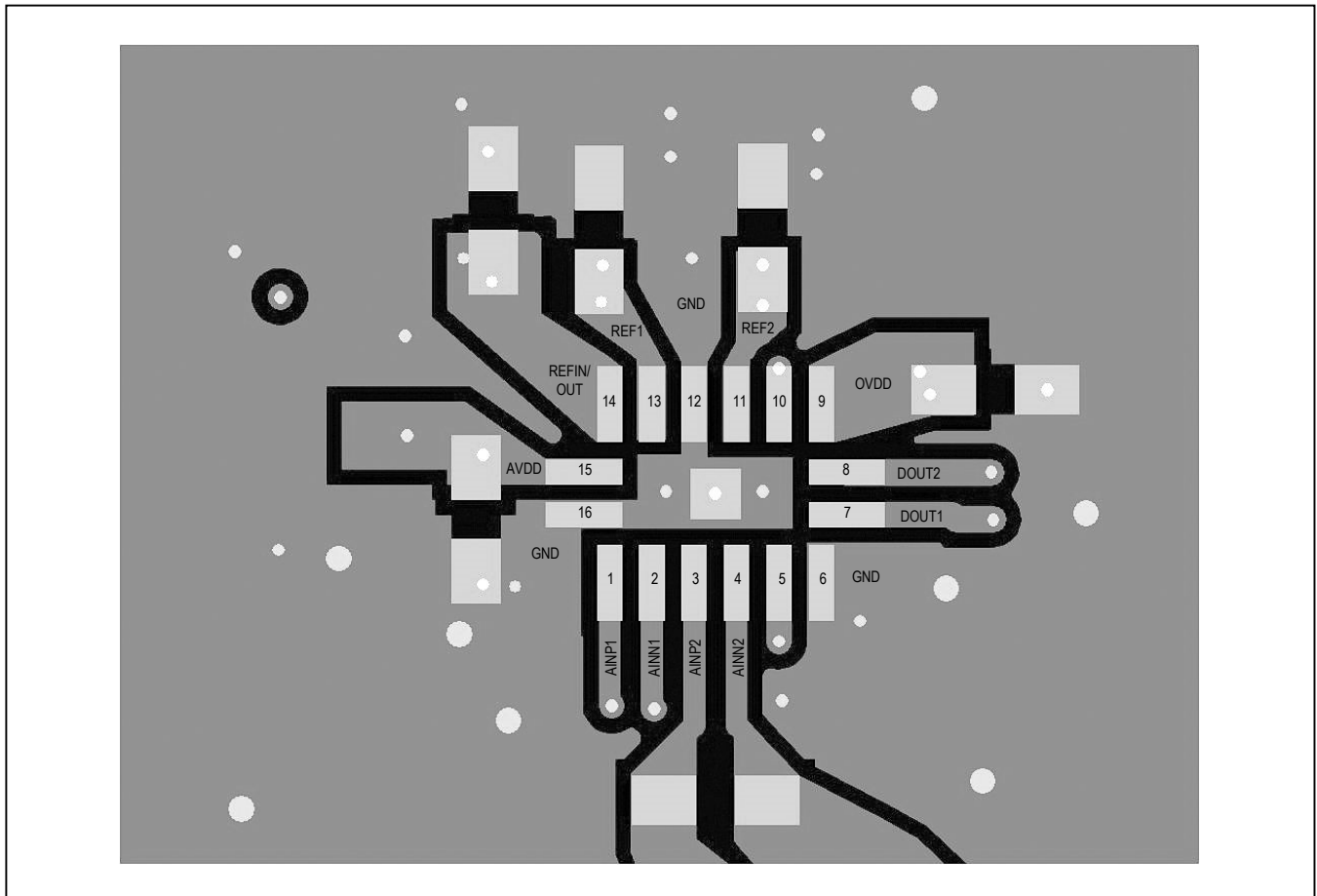

Figure 15. PCB Layout Example for MAX11192

MAX11192

12-Bit, 2Msps, Dual Simultaneous Sampling  
SAR ADCs with Internal Reference

### Ordering Information

PART NUMBER	RESOLUTION	TEMP RANGE	PIN-PACKAGE	REFERENCE
MAX11192ATE+	12	-40°C to +125°C	16 UTDFN-EP*	2.5V
MAX11192ATE+T	12	-40°C to +125°C	16 UTDFN-EP*	2.5V

*Denotes a lead(Pb)-free/RoHS-compliant package.*

*T = tape and reel.*

*\*EP = Exposed Pad*

## Revision History

REVISION NUMBER	REVISION DATE	DESCRIPTION	PAGES CHANGED
0	4/17	Initial release	—

For pricing, delivery, and ordering information, please contact Maxim Direct at 1-888-629-4642, or visit Maxim Integrated's website at [www.maximintegrated.com](http://www.maximintegrated.com).

*Maxim Integrated cannot assume responsibility for use of any circuitry other than circuitry entirely embodied in a Maxim Integrated product. No circuit patent licenses are implied. Maxim Integrated reserves the right to change the circuitry and specifications without notice at any time. The parametric values (min and max limits) shown in the Electrical Characteristics table are guaranteed. Other parametric values quoted in this data sheet are provided for guidance.*