

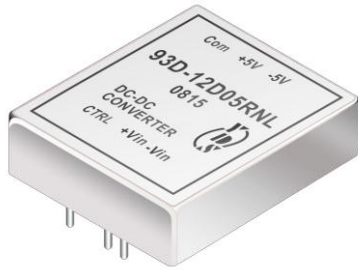

Wide Input Voltage Range 60 Watt Dc-Dc Converter



FEATURES:

- 60W DIL PACKAGE
- INDUSTRY STANDARD PACKAGE
- 2:1 WIDE INPUT RANGE
- 100% BURNED IN
- HIGH EFFICIENCY
- UL94V-0 PACKAGE MATERIAL
- CUSTOM SOLUTIONS AVAILABLE
- RoHS COMPLIANT
- 3 YEARS WARRANTY



Specifications typical at TA=25°C, nominal input voltage and rated output current unless otherwise specified

Part Number	Input Voltage Vdc	Input Current		Output Voltage Vdc	Output Current Full Load (mA)	Efficiency %TYP
		No-Load (mA TYP)	Full Load (mA TYP)			
93D-12S05RNL	9-18	40	5208	5	10000	80
93D-12S12RNL	9-18	40	5882	12	5000	85
93D-12S15RNL	9-18	40	5814	15	4000	86
93D-12D05RNL	9-18	40	5144	±5	±5000	81
93D-12D12RNL	9-18	40	5747	±12	±2500	87
93D-12D15RNL	9-18	40	5747	±15	±2000	87
93D-24S05RNL	18-36	30	2572	5	10000	81
93D-24S12RNL	18-36	30	2841	12	5000	88
93D-24S15RNL	18-36	30	2841	15	4000	88
93D-24D05RNL	18-36	30	2572	±5	±5000	81
93D-24D12RNL	18-36	30	2874	±12	±2500	87
93D-24D15RNL	18-36	30	2841	±15	±2000	88
93D-48S05RNL	36-72	20	1270	5	10000	82
93D-48S12RNL	36-72	20	1420	12	5000	88
93D-48S15RNL	36-72	20	1420	15	4000	88
93D-48D05RNL	36-72	20	1270	±5	±5000	82
93D-48D12RNL	36-72	20	1437	±12	±2500	87
93D-48D15RNL	36-72	20	1437	±15	±2000	87

Input Specifications

Parameters	Conditions	Min	Typ	Max	Units
Voltage Types				2:1	
Filter	PI Network				
Protection	Fuse Recommended				

Output Specifications (Temperature Coefficient : ±0.05%/°C)

Parameters	Conditions	Min	Typ	Max	Units
Voltage Tolerance	Full load@Vin(nom.)			±2	%
Short Circuit/ Restart Protection	Hiccup, automatic recovery				
Over Load Protection		120	150	180	%
Line Regulation	Single & Dual (H/L to L/L)			±0.5	%
Load Regulation	Single & Dual (Balance Load), 25% TO 100% load			±0.5	%
Cross Regulation	Dual (25% to 100% load)			±5	%
Ripple & Noise	BW=DC To 20MHz (with 1uF Cap.)			150	mVp-p
Transient response setting time	50% Step Load Change			400	us
Capacitive load				1500	uF
External Trim Adj. Range				±10	%

General Specifications

Parameters	Conditions	Min	Typ	Max	Units
Isolation Resistance	500Vdc	1000			MΩ
Switching Frequency			50		KHz
Operating Temperature	With derating	-40		85	°C
Humidity	Non Condensing			95	%
Cooling	Free air Convection				
Case material	Six-Side Shielded Case		Nickel Coated with Non-Conductive Base		
Weight			227		g
Dimensions			76.7X66.5X21.6		
Potting Material			Epoxy (UL94V-0 rated)		
Radiated Emissions	EN55022		CLASS A		
Conducted Emissions	EN55022		CLASS A		
Isolation Voltage	For 10 seconds			3000	VDC
MTBF	MIL-HDBK-217F @25°C, Ground Benign	299424			Hours
Storage Temperature		-55		+100	°C
Case Temperature				+90	°C
Isolation Capacitance				2500	pF



Wide Input Voltage Range 60 Watt Dc-Dc Converter

Temperature Derating Graph

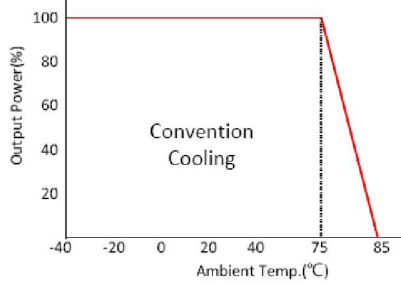

Tolerance Envelope Graph

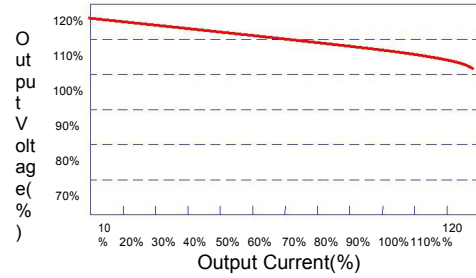

Part Number

93D - 12 S 05 R NL
A B C D E F

- A : Series
- B : Input Voltage
- C : Single Output(S), DUAL(D)
- D : Output Voltage
- E : Regulated(R)
- F : RoHs Version

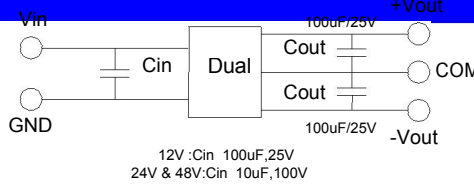
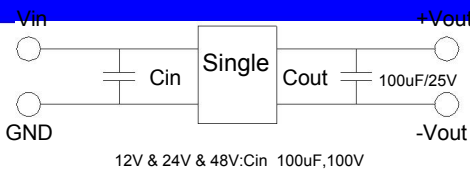

Suggest adding input external filter(C1,C2,C3,C4,C5,L) to meet conducted emissions (EN55022 class A) requirement for the module . These components should be mounted as close as possible to the module; and all leads should be minimized to decrease radiated noise.

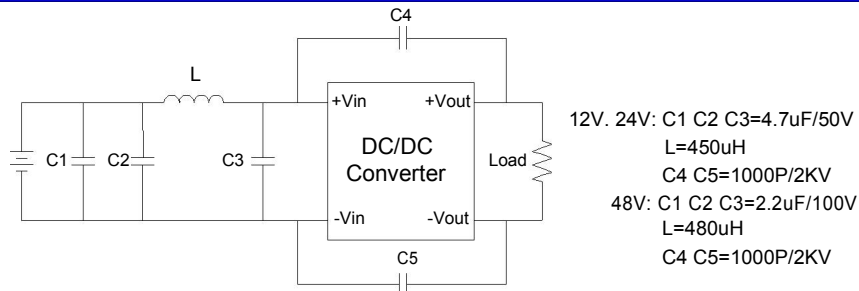

Markings and dimensions

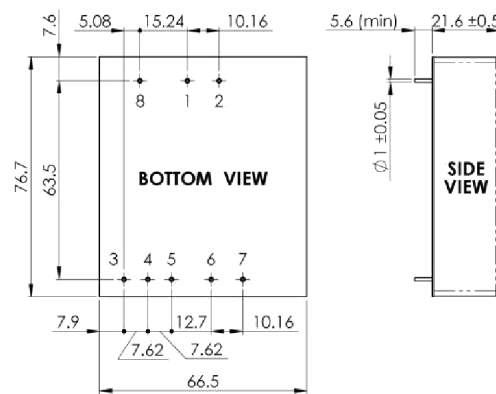

Unit : mm
Tolerance : XX.X ±0.5 , XX.XX ±0.25

PIN Assignment

PIN	1	2	3	4	5	6	7	8
SINGLE	+Vin	-Vin	NO PIN	Trim	NO PIN	+Vout	-Vout	Remote On/Off
DUAL	+Vin	-Vin	+Vout	Com	-Vout	NO PIN	NO PIN	Remote On/Off