

Evaluating the **AD5758** Single-Channel, 16-Bit Current and Voltage Output DAC with Dynamic Power Control and HART Connectivity

FEATURES

Full featured evaluation board for the **AD5758**
 On-board 2.5 V **ADR4525** reference
 SPI
ACE software for control

EVALUATION KIT CONTENTS

EVAL-AD5758SDZ evaluation board
EVAL-SDP-CS1Z

EQUIPMENT NEEDED

EVAL-SDP-CS1Z
 Bench top power supply and connector cables

DOCUMENTS NEEDED

AD5758 data sheet
 EVAL-AD5758SDZ evaluation board user guide
ACE User Manual

SOFTWARE NEEDED

ACE software for control

GENERAL DESCRIPTION

This user guide describes the evaluation board for the **AD5758**, a functional safety certified, single-channel, voltage and current output, digital-to-analog converter (DAC) with on-chip dynamic power control (DPC) that minimizes package power dissipation.

For full details on the **AD5758**, refer to the **AD5758** data sheet. Consult the data sheet when using the EVAL-AD5758SDZ. The configuration of the various link options is explained in the Evaluation Board Hardware section. The installation of the companion software is discussed in the Software Quick Start Procedures section.

The EVAL-AD5758SDZ, shown in Figure 1, requires the **EVAL-SDP-CS1Z** board. The EVAL-AD5758SDZ interfaces to the USB port of the PC via the **EVAL-SDP-CS1Z** board. Software that allows the user to easily program the **AD5758**, namely the **Analysis|Control|Evaluation (ACE)** software, is available with the EVAL-AD5758SDZ.

EVALUATION BOARD PHOTOGRAPH

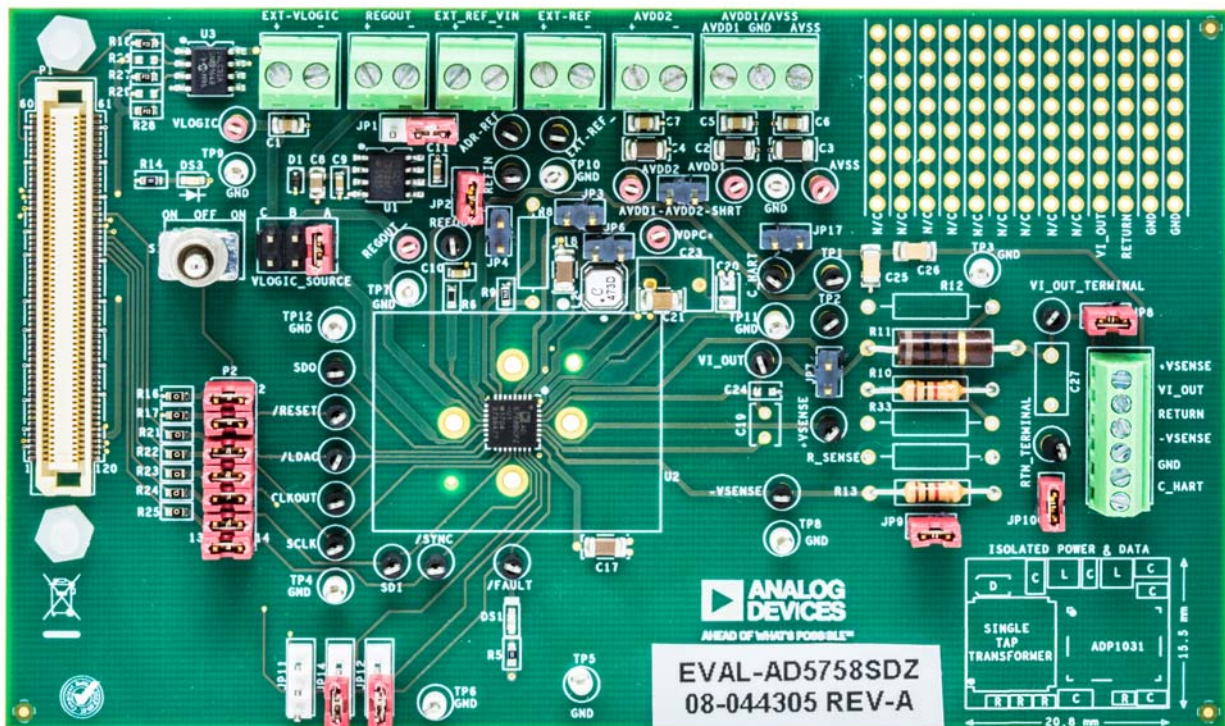

Figure 1.

TABLE OF CONTENTS

Features	1	AD5758 Block Diagram and Functions	7
Evaluation Kit Contents.....	1	Initial Configuration.....	9
Equipment Needed.....	1	DC-to-DC Converter Settings.....	9
Documents Needed.....	1	Setting the DAC Output	10
Software Needed	1	Writing to the ADC Configuration Register	10
General Description	1	Updating Diagnostic Results	10
Evaluation Board Photograph.....	1	Example Sequences	11
Revision History	2	ACE Tool Views.....	12
Evaluation Board Hardware.....	3	Macro Tool	12
Power Supplies	3	Register Debugger Tool	12
Serial Communication.....	3	Events Tool	12
AD5758 Device Under Test (DUT) Address Pins.....	3	Evaluation Board Schematics and Artwork.....	13
Software Quick Start Procedures.....	5	Ordering Information.....	19
Installing the Analysis Control Evaluation (ACE) Software		Bill of Materials.....	19
and AD5758 Plug-Ins	5		
Initial Setup	5		

REVISION HISTORY

5/2018—Revision 0: Initial Version

EVALUATION BOARD HARDWARE

POWER SUPPLIES

The EVAL-AD5758SDZ evaluation board requires a number of power supply inputs for AV_{DD1} , AV_{DD2} , AV_{SS} , and V_{LOGIC} . AV_{DD2} can be connected to AV_{DD1} via the AVDD1-AVDD2-SHRT link if there is only one positive rail available. The V_{LOGIC} supply can be selected from 3.3V_SDP, V_{LDO} , or EXT-VLOGIC through the VLOGIC_SOURCE link. See Table 1 for more link options. See Table 3 for the default link positions.

The EVAL-AD5758SDZ evaluation board operates with a power supply range from -33 V on AV_{SS} to $+33$ V on AV_{DD1} , with a maximum voltage between the two rails of 60 V. AV_{DD2} requires a voltage between 5 V and 33 V. V_{DPC+} can be driven by AV_{DD1} via Jumper JP6. Jumper JP6 bypasses the dc-to-dc circuitry.

SERIAL COMMUNICATION

The EVAL-SDP-CS1Z (SDP-S) system demonstration platform handles communication to the EVAL-AD5758SDZ via the PC. By default, the SDP-S handles the serial port interface (SPI) communication, controls the \overline{RESET} and \overline{LDAC} pins, and monitors the FAULT pin of the AD5758.

The EVAL-AD5758SDZ evaluation board has the option to disconnect from the SDP-S and drive the digital signals from an external source by removing the appropriate links on P2. An option to tie \overline{RESET} and \overline{LDAC} to high or low levels can be accessed through the S1 and JP11 links.

AD5758 DEVICE UNDER TEST (DUT) ADDRESS PINS

The DUT address pins, AD0 and AD1, are used in conjunction with the DUT address bits within the SPI frame to determine which AD5758 device is being addressed by the system controller. AD0 and AD1 can be configured through JP12 and JP14.

Table 1. EVAL-AD5758SDZ Link Option Functions

Link	Function
AVDD1-AVDD2-SHRT	Connects AV_{DD2} to AV_{DD1} .
VLOGIC_SOURCE	Position A selects 3.3 V from the SDP-S. Position B selects 3.3 V from the V_{LDO} pin of the AD5758. Position C selects the external logic supply, EXT-VLOGIC.
JP1	Position A powers ADR-REF from EXT_REF_VIN. Position B powers ADR-REF from AV_{DD2} (the maximum supply for the ADR4525 is 15 V).
JP2	Selects ADR-REF as the input to REFIN.
JP3	Selects EXT-REF as the input to REFIN.
JP4	Selects REFOUT as the input to REFIN.
JP6	Shorts V_{DPC+} to AV_{DD1} , bypassing the positive dc-to-dc circuitry.
JP8	Connects V_{IOUT} to $+V_{SENSE}$.
JP9	Connects the RETURN signal to GND.
JP10	Connects $-V_{SENSE}$ to the RETURN signal.
JP11	Position A connects \overline{LDAC} to GND. Position B connects \overline{LDAC} to V_{LOGIC} .
JP12	Position A connects AD0 to GND. Position B connects AD0 to V_{LOGIC} .
JP14	Position A connects AD1 to GND. Position B connects AD1 to V_{LOGIC} .
JP17	Connects AV_{SS} to GND for the unipolar supply option (current output only).
P2	Provides options to disconnect from the SDP-S and to drive digital signals from an external source. See Table 2 for the specific link options.
S1	Position 2-1 (on position to the right of off) connects \overline{RESET} to GND. Position 2-3 (on position to the left of off) connects \overline{RESET} to V_{LOGIC} .

Table 2. Link Options for Link P2

Pin No.	Position	Function
1, 2	Inserted	Connects the $\overline{\text{FAULT}}$ signal from the SDP-S to the $\overline{\text{FAULT}}$ pin on the AD5758
	Not inserted	Disconnects the $\overline{\text{FAULT}}$ signal from the SDP-S to the $\overline{\text{FAULT}}$ pin on the AD5758
3, 4	Inserted	Connects the $\overline{\text{RESET}}$ signal from the SDP-S to the $\overline{\text{RESET}}$ pin on the AD5758
	Not inserted	Disconnects the $\overline{\text{RESET}}$ signal from the SDP-S to the $\overline{\text{RESET}}$ pin on the AD5758
5, 6	Inserted	Connects the $\overline{\text{LDAC}}$ signal from the SDP-S to the $\overline{\text{LDAC}}$ pin on the AD5758
	Not inserted	Disconnects the $\overline{\text{LDAC}}$ signal from the SDP-S to the $\overline{\text{LDAC}}$ pin on the AD5758
7, 8	Inserted	Connects the SCLK signal from the SDP-S to the SCLK pin on the AD5758
	Not inserted	Disconnects the SCLK signal from the SDP-S to the SCLK pin on the AD5758
9, 10	Inserted	Connects the SDO signal from the SDP-S to the SDO pin on the AD5758
	Not inserted	Disconnects the SDO signal from the SDP-S to the SDO pin on the AD5758
11, 12	Inserted	Connects the SDI signal from the SDP-S to the SDI pin on the AD5758
	Not inserted	Disconnects the SDI signal from the SDP-S to the SDI pin on the AD5758
13, 14	Inserted	Connects the $\overline{\text{SYNC}}$ signal from the SDP-S to the $\overline{\text{SYNC}}$ pin on the AD5758
	Not inserted	Disconnects the $\overline{\text{SYNC}}$ signal from the SDP-S to the $\overline{\text{SYNC}}$ pin on the AD5758

Table 3. Default Link Positions

Link	Position	Function
AVDD1-AVDD2-SHRT	Not inserted	Connects AV _{DD2} to AV _{DD1}
VLOGIC_SOURCE	A	Selects 3.3 V from the SDP-S
JP1	B	Powers ADR-REF from AV _{DD2}
JP2	Inserted	Selects ADR-REF as the input to REFIN
JP3	Not inserted	Selects EXT-REF as the input to REFIN
JP4	Not inserted	Selects REFOUT as the input to REFIN
JP6	Not inserted	Connects V _{DPC+} to AV _{DD1} , bypassing the positive dc-to-dc circuitry
JP8	Inserted	Connects V _{IOUT} to +V _{SENSE}
JP9	Inserted	Connects the RETURN signal to AGND
JP10	Inserted	Connects -V _{SENSE} to the RETURN signal
JP11	A	Ties the $\overline{\text{LDAC}}$ signal to DGND
JP12	A	Connects AD0 to DGND
JP14	A	Connects AD0 to DGND
JP17	Not inserted	Connects AVSS to AGND for the unipolar supply option
P2	All links inserted	Connects all available signals from the SDP-S to the AD5758
S1	On	Connects the $\overline{\text{RESET}}$ signal to V _{LOGIC}

SOFTWARE QUICK START PROCEDURES

INSTALLING THE ANALYSIS|CONTROL| EVALUATION (ACE) SOFTWARE AND AD5758 PLUG-INS

The EVAL-AD5758SDZ software uses the Analog Devices, Inc., ACE software. For instructions on how to install and use the ACE software, go to www.analog.com/ACE.

After the installation finishes, the EVAL-AD5758SDZ evaluation board plug-in appears when opening the ACE software (see Figure 2).

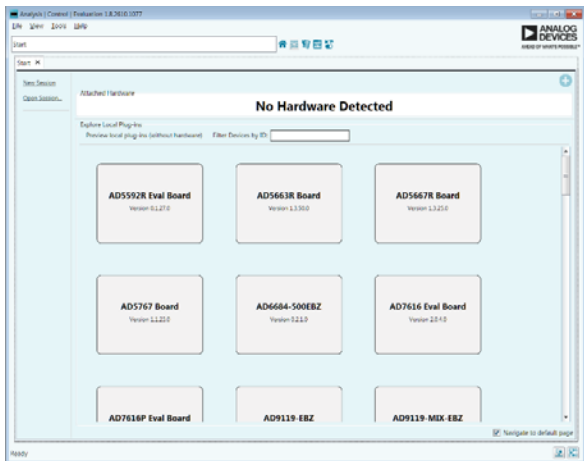

Figure 2. EVAL-AD5758SDZ Evaluation Board Plug-in Window after Opening the ACE Software

INITIAL SETUP

To set up the EVAL-AD5758SDZ, take the following steps:

1. Connect a USB cable to the PC and then to the EVAL-SDP-CS1Z (SDP-S).
2. Connect the EVAL-SDP-CS1Z (SDP-S) to the EVAL-AD5758SDZ. The PC recognizes the EVAL-AD5758SDZ.
3. Power up the EVAL-AD5758SDZ with the relevant power supplies.
4. If not opened already, open the ACE software. The EVAL-AD5758SDZ appears in the **Attached Hardware** section.

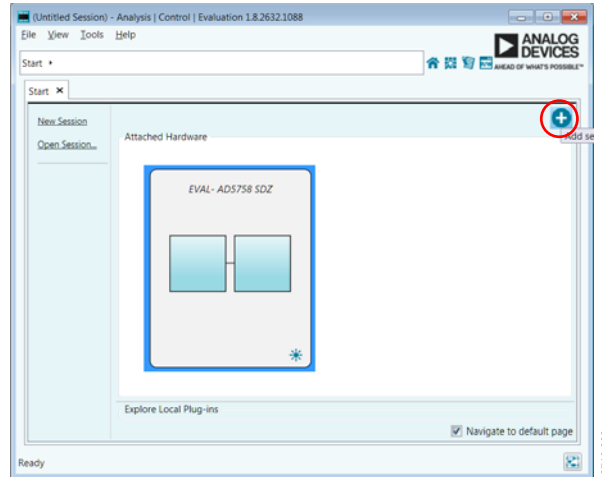

Figure 3. EVAL-AD5758SDZ Plug-In Not Installed

5. When setting up the evaluation board for the first time, the EVAL-AD5758SDZ plug-in may need to be installed. If the plug-in appears as shown in Figure 6, then go to Step 7. If the plug-in appears as shown in Figure 3, then click on the button circled in red in Figure 3. After clicking this button, the pop-up window shown in Figure 4 appears. Click yes.

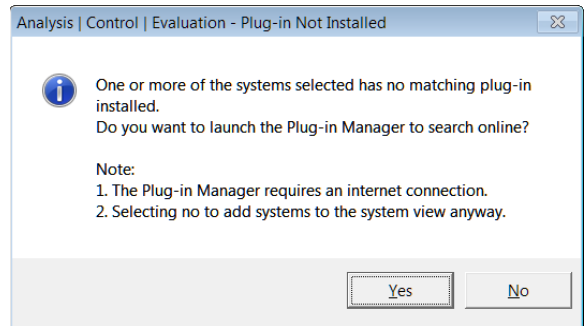

Figure 4. Installing the Plug-In Pop-Up Window

6. A new window appears as shown in Figure 5. Find the **Board.AD5758** plug-in and click the **Install Selected** button. The EVAL-AD5758SDZ plug-in is now installed and is displayed as shown in Figure 6.

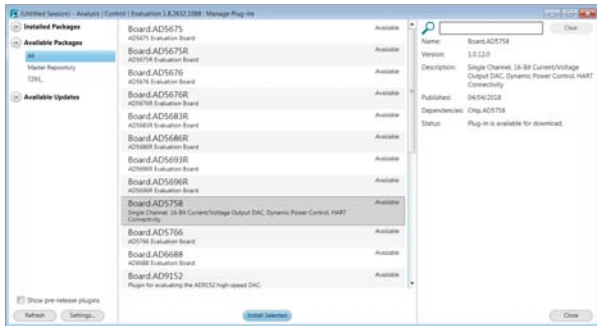

Figure 5. Plug-In Manager Window

7. Double-click EVAL-AD5758SDZ to open the **AD5758** block diagram (see Figure 7). The **INITIAL CONFIGURATION** menu appears on the left. This location is where several register settings can be configured and are written to the device in the appropriate order. The **DIG_DIAG_STATUS**, **RESET_OCCURED**, and **CAL_MEM_UNREFRESHEDLED** indicators are highlighted red by default. Writing the initial configuration values clears these error flags. If the device is power cycled, or if the USB cable is disconnected and reconnected while the **ACE** software is open, contact with the EVAL-AD5758SDZ may be lost. If contact is lost, click the **System** tab. Then, click the **USB** symbol on the EVAL-AD5758SDZ, and then click **Acquire** to communicate with the EVAL-AD5758SDZ again.

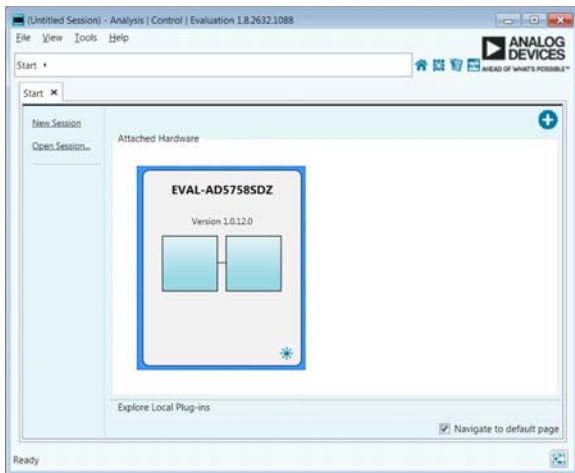

Figure 6. Attached Hardware Section when the EVAL-AD5758SDZ is Connected

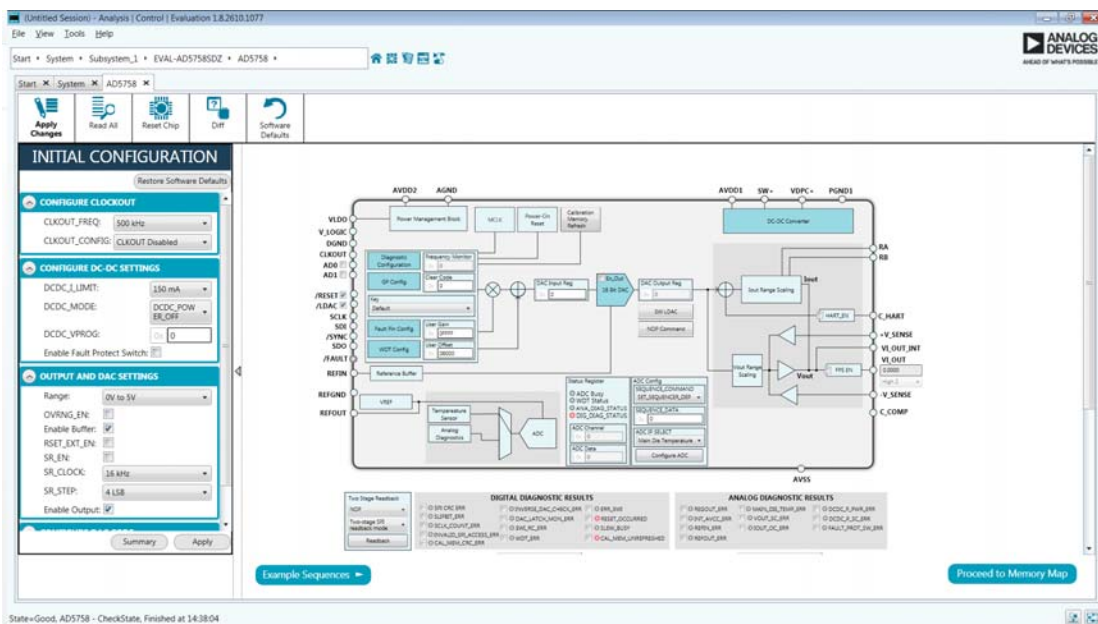

Figure 7. AD5758 Block Diagram in the ACE Software

AD5758 BLOCK DIAGRAM AND FUNCTIONS

The AD5758 ACE plug-in is organized so that it appears similar to the block diagram shown in the AD5758 data sheet. In this way, it is easy to correlate the functions on the EVAL-AD5758SDZ with the descriptions in the AD5758 data sheet.

A full description of each block and register setting is available in the AD5758 data sheet. The full screen AD5758 block diagram, with labels, is shown in Figure 8. Table 4 describes the functionality of each block.

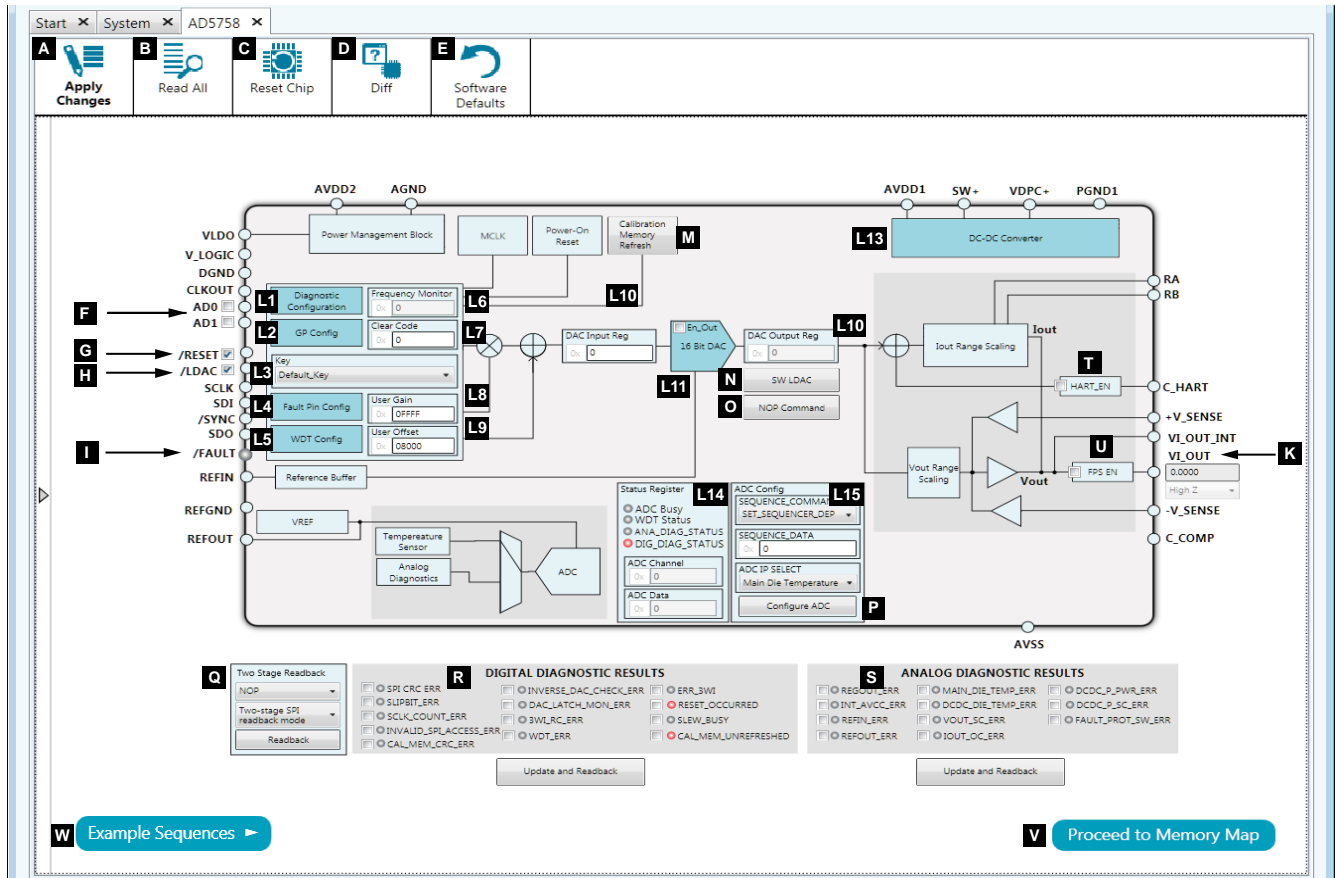

Figure 8. AD5758 Block Diagram with Labels

Table 4. AD5758 Block Diagram Label Functions (See Figure 8)

Label	Function
A	To apply any changes made to the block diagram or to register values in the memory map to the device, click Apply Changes .
B	To read back all of the registers of the device, click Read All .
C	Click Reset Chip to reset the AD5758. Reset Chip has the same functionality as the software reset of the AD5758.
D	Click Diff to show the registers that are different from the data stored on the device. This function shows what changed since the last time the registers were read.
E	Click Software Defaults to load the software defaults of the device. These values are not written to the hardware. Click Apply Changes (Label A) to write the software default values to the hardware.
F	The AD0 and AD1 check boxes set the DUT address of the device and must correspond to JP12 and JP14 on the hardware. If either box is checked, this represents a high state. If either box is unchecked, this represents a low state.
G	If the /RESET box is checked, the SDP-S sets the $\overline{\text{RESET}}$ pin high. Otherwise, the SDP-S pulls $\overline{\text{RESET}}$ low.
H	If the /LDAC box is checked, the SDP-S sets the $\overline{\text{LDAC}}$ pin high. Otherwise, the SDP-S pulls $\overline{\text{LDAC}}$ low.
I	The ACE plug-in monitors the $\overline{\text{FAULT}}$ pin. If the $\overline{\text{FAULT}}$ pin is low, the /FAULT indicator LED lights up red.
K	VI_OUT displays the calculated output at VI_OUT, and also displays if the output is in voltage, milliamps, or is high impedance (high-Z).
Lx	GUI access on several registers. Pop-ups, drop-down menus, and hexadecimal textboxes are available in the GUI to configure several registers of the AD5758. To write the changes to the device, the Apply Changes button (Label A) must be clicked. The functions within the GUI that control various registers (Label L1 through Label L15) are described in Table 5.
M	The Calibration Memory Refresh button initiates a write to the key register to perform a calibration memory refresh.
N	The SW LDAC button initiates a write to the key register to perform a software $\overline{\text{LDAC}}$ command.
O	The NOP Command button initiates a write to Address 0x00 for a no operation (NOP) command.
P	The Configure ADC button writes the data selected in the ADC Config menu (Label L15) to the ADC configuration register.
Q	Two Stage Readback Select menu. Two stage readback is initiated through the two stage readback select register. Clicking the Readback button initiates a write to the two stage readback select register and then issues a no operation command.
R	DIGITAL DIAGNOSTIC RESULTS menu. Clicking the Update and Readback Digital Diagnostic Result button triggers a write 1 to clear operation and a readback from the digital diagnostic result register.
S	ANALOG DIAGNOSTIC RESULTS menu. Clicking the Update and Readback Analog Diagnostic Result button triggers a write 1 to clear operation and a readback from the analog diagnostic result register.
T	If the HART_EN box is checked, the HART_EN bit = 1 in the General-Purpose Configuration 1 register.
U	If the FPS_EN box is checked, the FAULTPROT_SW_EN bit = 1 in the DC-to-DC Configuration 1 register.
V	Click the Proceed to Memory Map button to open the AD5758 memory map (see Figure 9).
W	Click the Example Sequences button to open the example sequences window (see Figure 15).

Table 5. Register Controls Accessible via the GUI (See Label Lx in Table 4 and in Figure 8)

Label	Function
L1	Diagnostic Configuration. Clicking this button activates the associated pop-up menu.
L2	GP Config. When this button clicked, a pop-up menu appears.
L3	Key register menu. When this menu is clicked, a drop-down menu appears.
L4	Fault Pin Config. When this button is clicked, a pop-up menu appears.
L5	WDT Config. When this button is clicked, a pop-up menu appears.
L6	Frequency Monitor menu. This menu displays the value in the frequency monitor when read.
L7	Clear Code menu. Use the textbox in this menu to insert a clear code value in hexadecimal format.
L8	User Gain menu. Use the textbox in this menu to insert a user gain value in hexadecimal format.
L9	User Offset menu. Use the textbox in this menu to insert a user offset value in hexadecimal format.
L10	DAC Input Reg menu. Use the textbox in this menu to insert the DAC value in hexadecimal format.
L11	16 Bit DAC. When this button is clicked, a pop-up menu appears.
L12	DAC Output Reg. This menu displays the hexadecimal value currently set in the DAC output register.
L13	DC-DC Converter. When this button is clicked, the dc-to-dc configuration pop-up menu appears.
L14	Status Register. This menu displays the contents of the status register.
L15	ADC Config. This menu contains a combination of drop-down menus and a textbox in which to enter the sequence data.

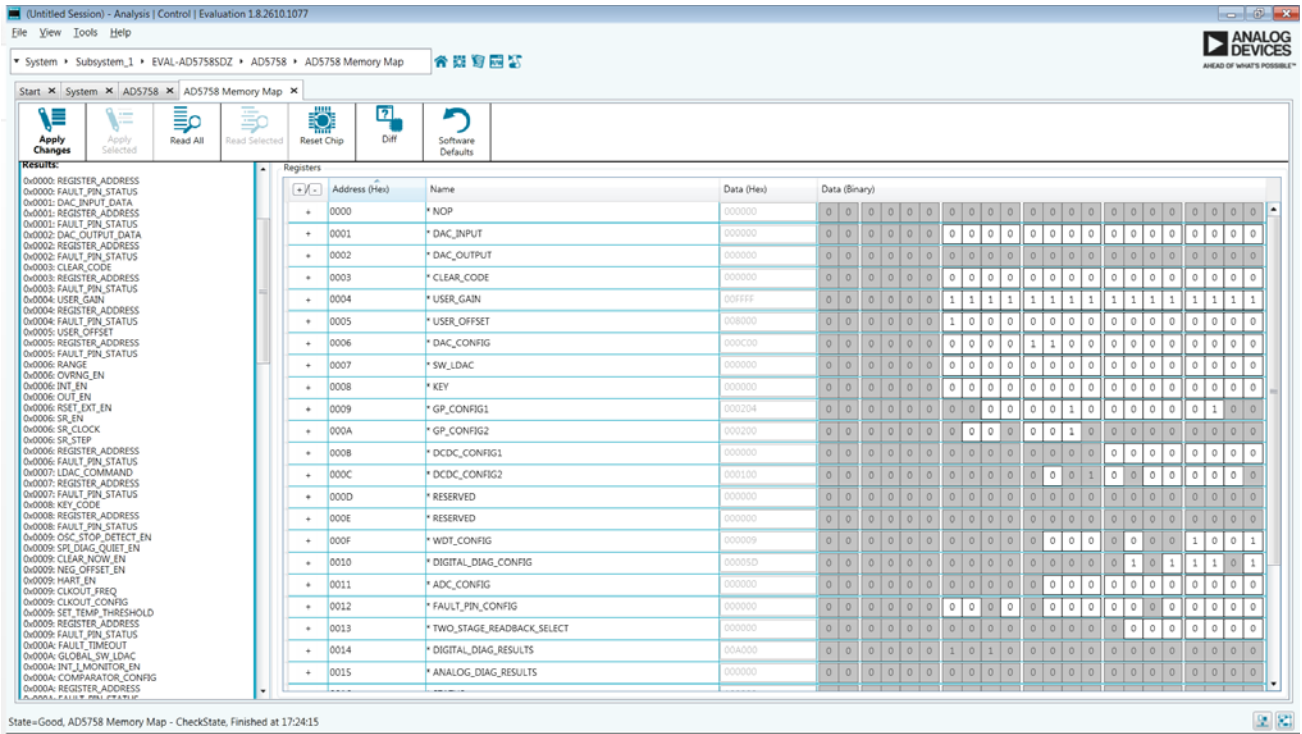

Figure 9. AD5758 Memory Map in the ACE Software

INITIAL CONFIGURATION

An initial configuration wizard is available when opening the AD5758 plug-in. The initial configuration wizard allows quick configuration of the AD5758 and provides configuration of the clock output in the general-purpose configuration register, the dc-to-dc settings, DAC configuration, and the DAC input register. Clicking the **Apply** button initiates the configured settings in the order of the recommended power-up sequence described in the AD5758 data sheet.

DC-TO-DC CONVERTER SETTINGS

If the V_{DPC+} pin is not tied directly to AVDD1, then the dc-to-dc converter must be enabled for correct operation. This step must be completed before configuring the DAC output. The **DC-DC Configuration** popup menu, shown in Figure 10, contains the dc-to-dc settings required to configure the AD5758 output correctly. After the desired settings are selected, click the **Close** button and then click **Apply Changes**.

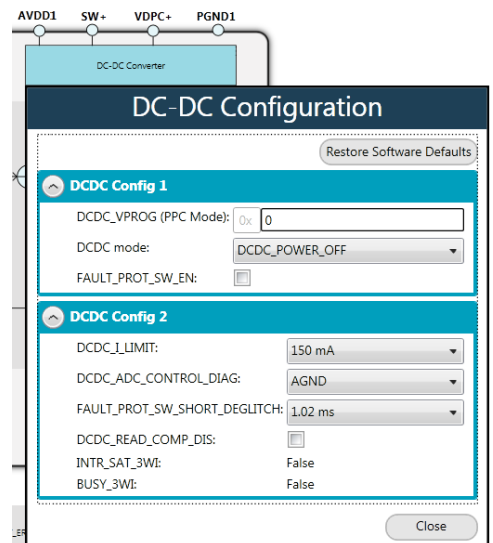

Figure 10. DC-DC Configuration Pop-Up Menu

SETTING THE DAC OUTPUT

To configure the DAC output, use the pop-up menu for the DAC configuration register (see Figure 11), available in the GUI. Click the **16 Bit DAC** symbol in the GUI to display the DAC configuration register. Select the appropriate settings, and then click **Apply Changes**. It is recommended to disable the output until the correct value in the DAC input register is written to the device.

To change the DAC voltage/current output level, write the appropriate hexadecimal code to the DAC input register and then click **Apply Changes**. Issue a software LDAC command using the **SW LDAC** button, or pull the LDAC pin low to update the DAC output register with the values in the DAC input register. Ensure that the fault protect switch, FPS_EN, is enabled before enabling the output. Enable the DAC output, OUT_EN, and then click **Apply Changes**. The programmed voltage/current is then reflected at the VI_{OUT} pin.

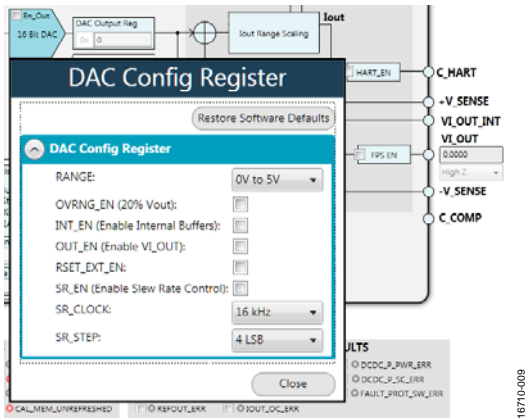

Figure 11. AD5758 DAC Config Register Pop-Up Menu

WRITING TO THE ADC CONFIGURATION REGISTER

The procedure to set up and configure the ADC sequencer is discussed in detail in the AD5758 data sheet. For this reason, writing to the ADC configuration register through the **Apply Changes** function is disabled.

Drop-down menus and a hexadecimal textbox are available within the GUI (see Figure 12) to access the ADC configuration register. Clicking the **Configure ADC** button initiates a write to the ADC configuration register.

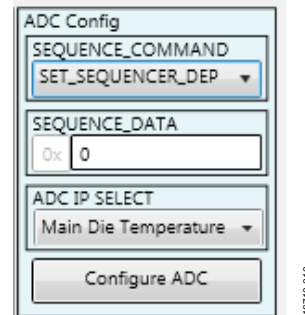

Figure 12. AD5758 ADC Configuration Register

UPDATING DIAGNOSTIC RESULTS

The AD5758 has a digital diagnostic results register and an analog diagnostic results register, both of which contain error flags for the on-chip digital and analog diagnostic features. Writing 1 to the respective error flags updates the error flag status.

To update the digital and analog diagnostic result registers, an **Update and Readback** button is available on the ACE GUI. Clicking this button initiates the writing of a 1 to the selected error flag and then reads back the updated diagnostic result. Figure 13 shows the digital diagnostic results register. Figure 14 shows the analog diagnostic results register.

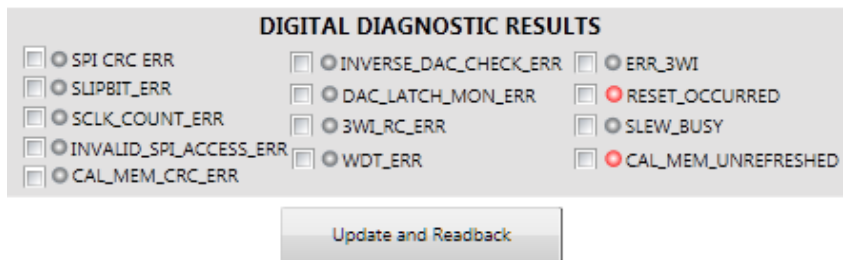

Figure 13. AD5758 Digital Diagnostic Register

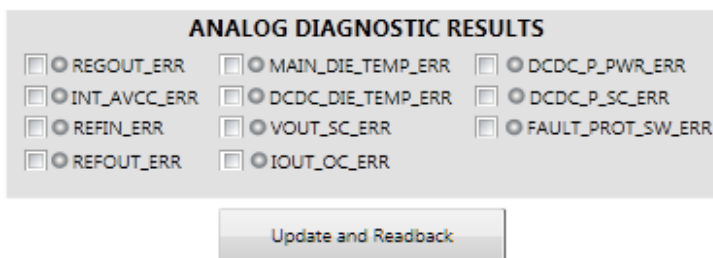

Figure 14. AD5758 Analog Diagnostic Register

EXAMPLE SEQUENCES

There are several example sequences available. Click the **Example Sequences** button and the window shown in Figure 15 appears. To enable any of the sequences, click on the relevant sequence

button, as shown in Figure 16. The sequence runs immediately and the output changes accordingly. To return to the main window, click the **Back to the AD5758** button.

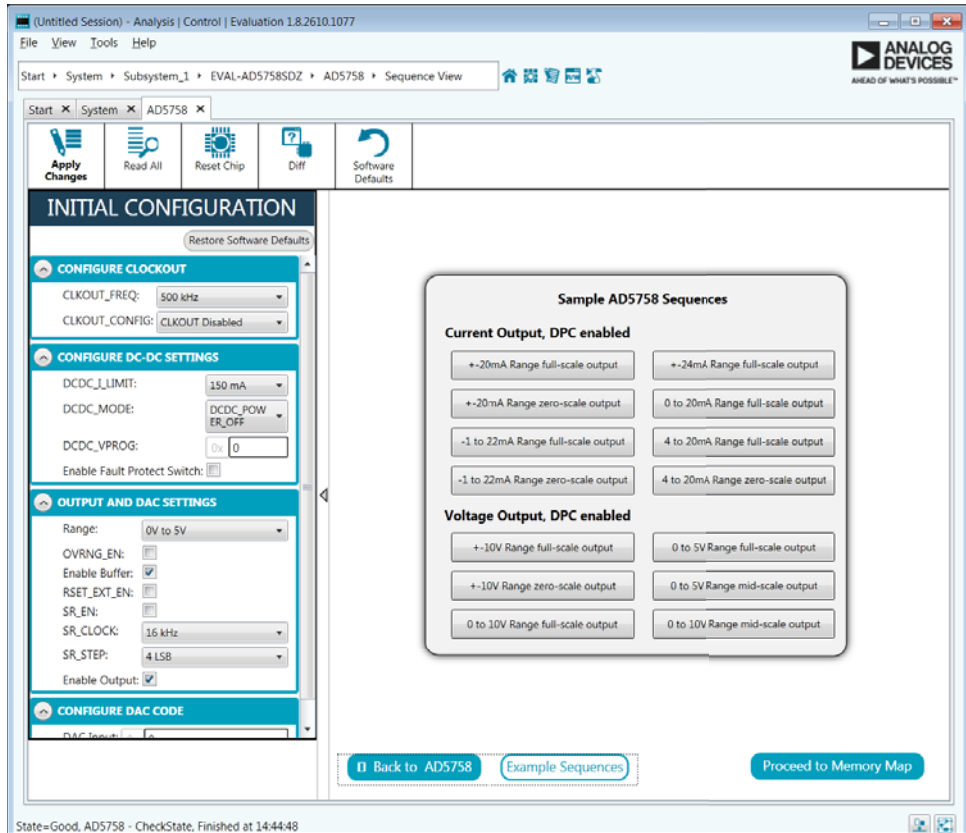

Figure 15. Example Sequences Window

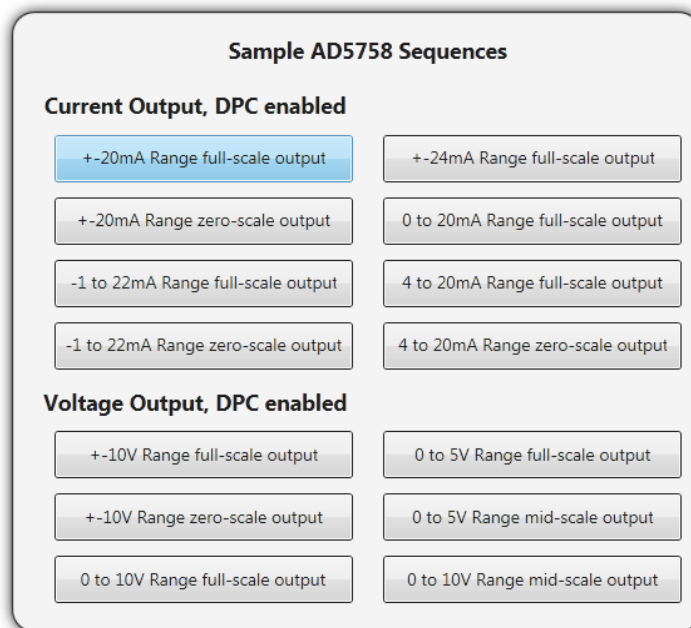

Figure 16. Selecting an Example Sequence

ACE TOOL VIEWS

The [ACE](#) software provides additional functionality to the main view described in this user guide. Open these views from the view menu item on the application toolbar. [ACE](#) features a macro tool, a register debugger tool, and an events tool.

MACRO TOOL

The macro tool allows commands to be recorded and saved as an [ACE](#) macro file. This feature is useful when sharing macros with other users to perform the same task multiple times. The user can import and run an [ACE](#) macro file.

REGISTER DEBUGGER TOOL

Use the register debugger tool to perform raw writes to and reads from the device. The register debugger affects only the hardware and does not write to the memory map of [ACE](#).

EVENTS TOOL

The events tool view contains a list of errors, warnings, and information messages generated within the application software.

SCHEMATIC PAGE - DUT & SUPPLY

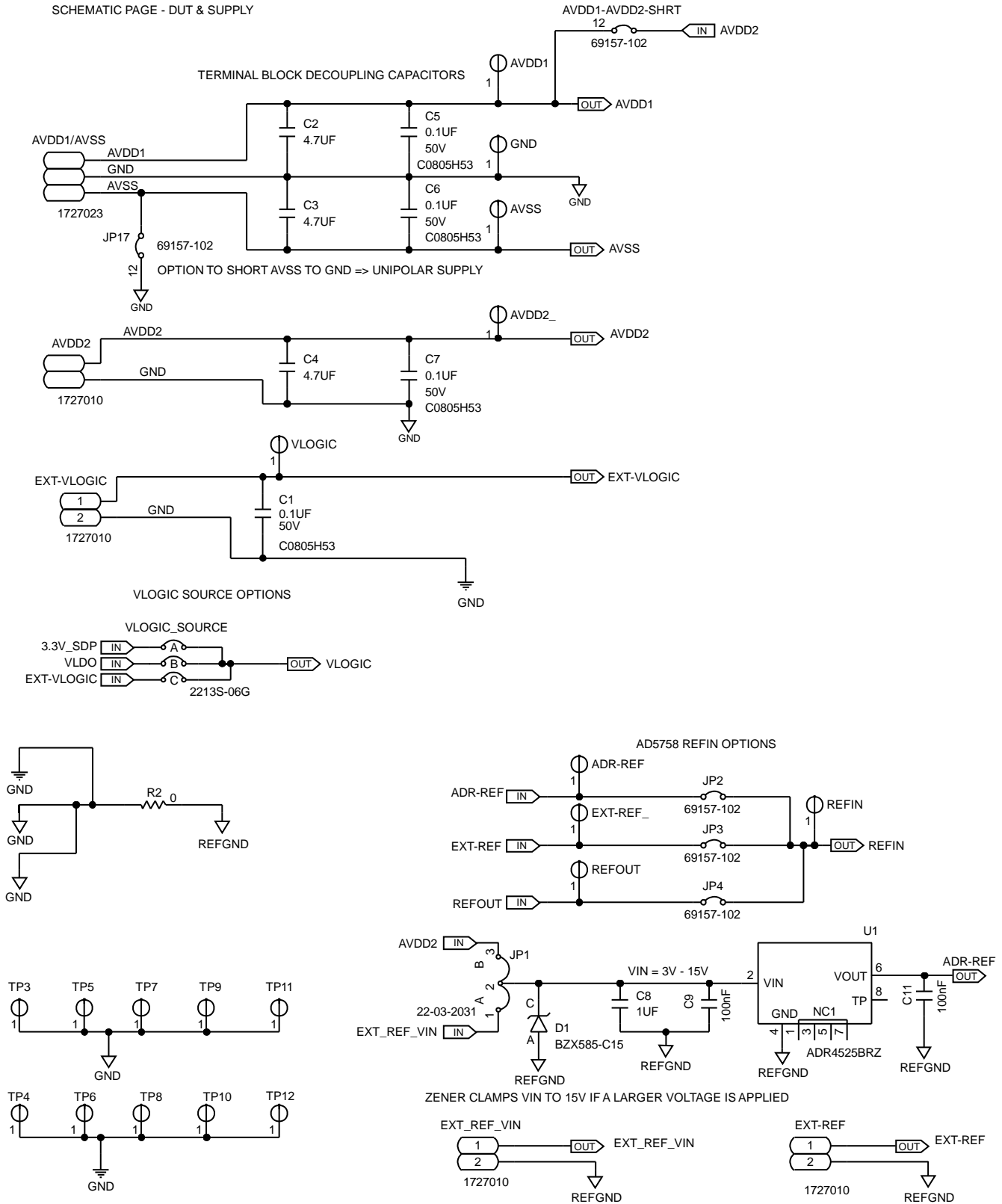

Figure 18. AD5758 Supplies and Reference Options

1671b0014

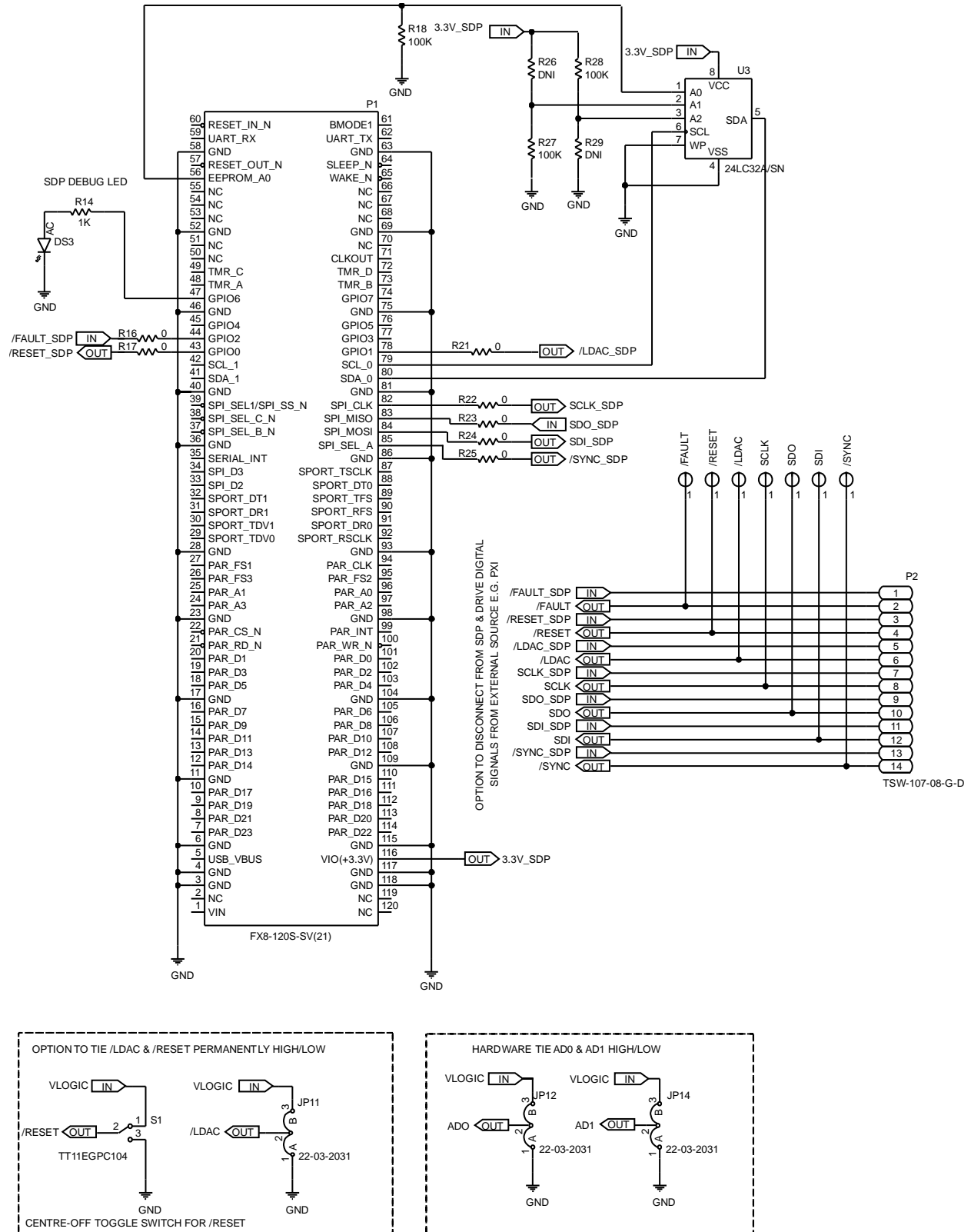

Figure 19. SDP-5 Board Connections, Address Pins, and LDAC and RESET Pins

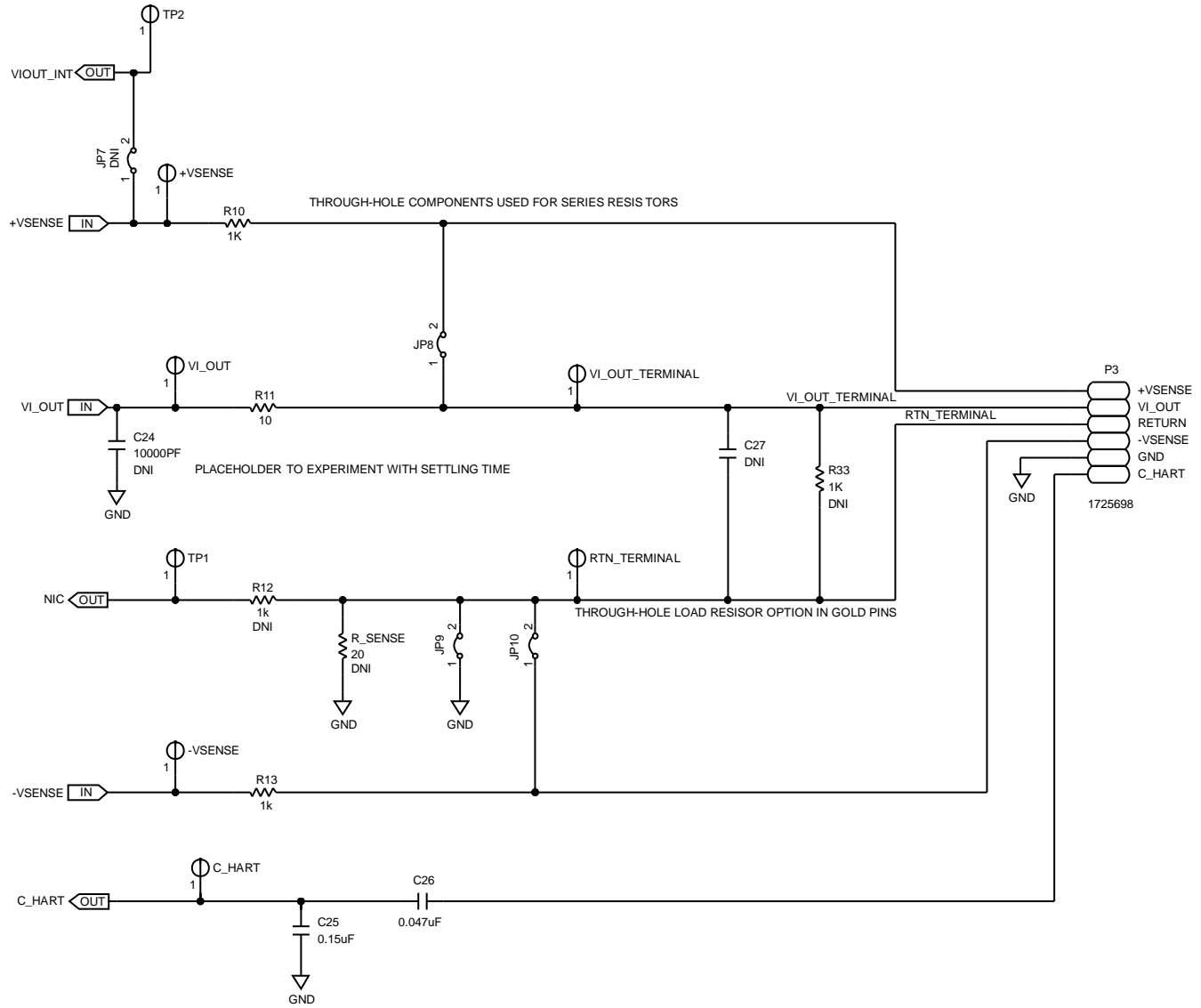

Figure 20. AD5758 Output Stage

167 10-016

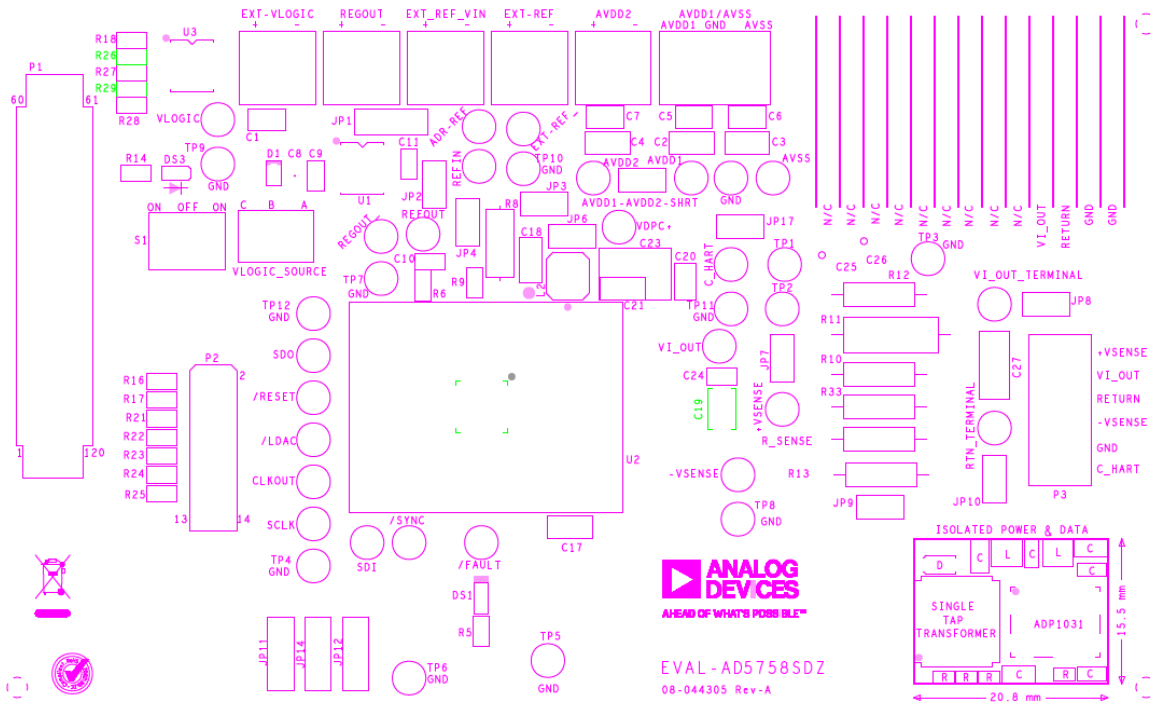

Figure 21. Silkscreen

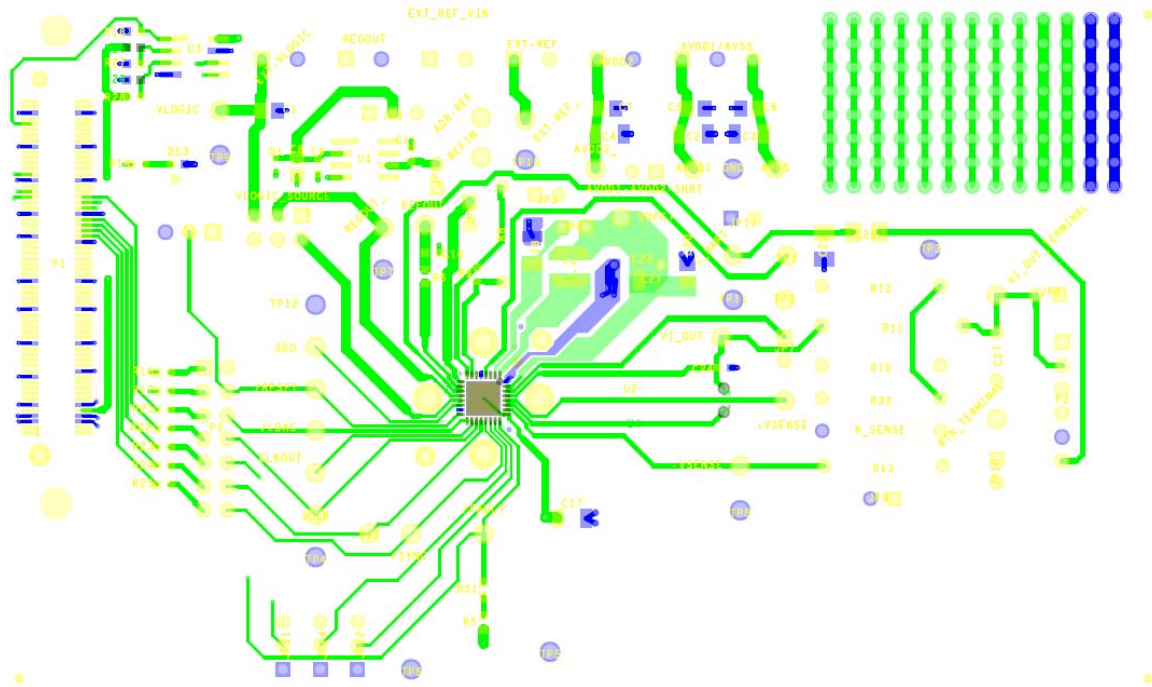
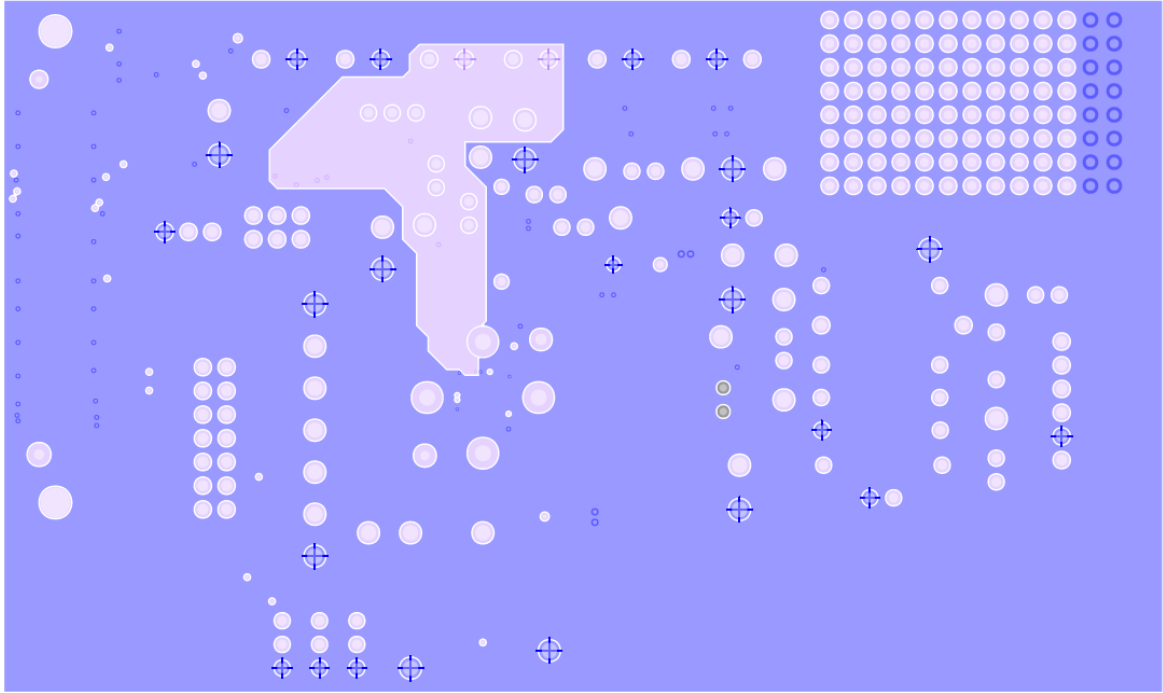
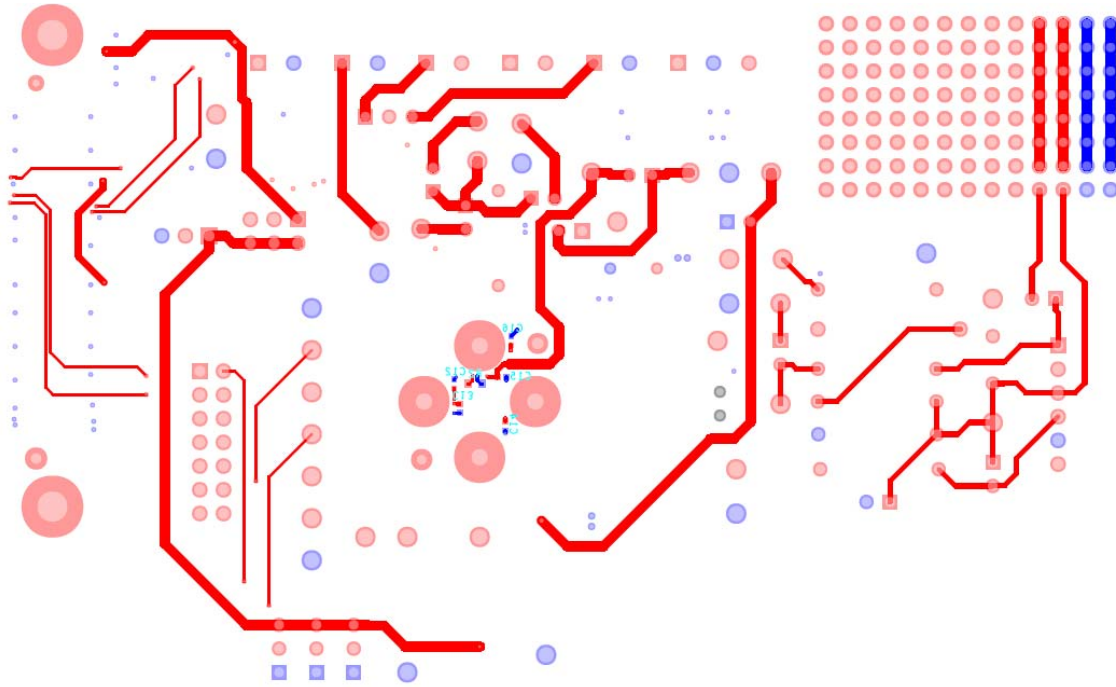

Figure 22. Layer 1



16710-019

Figure 23. Ground and Power Plane, Layer 2 and Layer 3



16710-020

Figure 24. Layer 4 (Secondary)

ORDERING INFORMATION

BILL OF MATERIALS

Table 6. Bill of Materials

Reference Designator	Description	Manufacturer	Part Number
+VSENSE, -VSENSE, /FAULT, /LDAC, /RESET, /SYNC, ADR-REF, CLKOUT, CHART, EXT-REF, REFIN, REFOUT, RTN_TERMINAL, SCLK, SDI, SDO, TP1, TP2, VIOUT, VI_OUT_TERMINAL	Black test points	Components Corporation	TP-104-01-00
AVDD1, AVDD2, AVSS, REGOUT_, VDPC+, VLOGIC	Red test points	Components Corporation	TP-104-01-02
AVDD1-AVDD2-SHRT, JP2, JP3, JP4, JP6, JP7, JP8, JP9, JP10, JP17	2-pin jumpers	Amphenol FCI	69157-102
AVDD1/AVSS	3-pin header	Phoenix Contact	1727023
AVDD2, EXT-REF, EXT-VLOGIC, EXT_REF_VIN, REGOUT	2-pin headers	Phoenix Contact	1727010
C1, C5, C6, C7	0.1 µF capacitors	Murata	GRM21BR71H104KA01L
C10	2.2 µF capacitor	Murata	GRM188R60J225KE19D
C9, C11	100 nF capacitors	Dielectric Labs	P62BN820MA2636
C12, C13, C14, C15, C16	0.1 µF capacitors	TDK	CGA2B3X7R1H104K050BB
C2, C3, C4, C17, C18	4.7 µF capacitors	Murata	GRM31CR71H475KA12L
C21	2.2 µF capacitor	Murata	GRM31CR71H225KA88L
C25	0.15 µF capacitor	AVX	12065C154KAT2A
C26	0.047 µF capacitor	AVX	12065C473JAT2A
C8	1 µF capacitor	Murata	GCM21BR71E105KA56L
D1	Zener diode	NXP Semiconductors	BZX585-C15
DS1	Red LED	Vishay	TLMS1000-GS08
DS3	Green LED	Lumex	SML-LX0603GW-TR
GND, TP3, TP4, TP5, TP6, TP7, TP8, TP9, TP10, TP11, TP12	White test points	Components Corporation	TP-104-01-09
JP1, JP11, JP12, JP14	3-pin jumpers	Molex	22-03-2031
L2	47 µH inductor	Coilcraft Inc.	LPS4018-473MRB
P1	120-pin connector	HRS	FX8-120S-SV(21)
P2	7 row, 2-pin header	Samtec	TSW-107-08-G-D
P3	6-pin header	Phoenix Contact	1725698
R_SENSE	20 Ω resistor (not inserted)	Vishay-Dale	CMF-5520R0BT-2
R2, R16, R17, R21, R22, R23, R24, R25	0 Ω resistors	Multicomp	MC0603WG00000T5E-TC
R6	500 Ω resistor	Vishay Precision Group	CRCW0603500RFKEA
R8	13.7 kΩ resistor	TE Connectivity	YR1B13K7CC
R9	13.7 kΩ resistor	TE Connectivity	RN73C1J13K7BTDF
R10, R12, R13	1 kΩ resistors	Yageo	CFR-25JB-1K0
R11	10 Ω resistor	Ohmite	OE1005
R5, R14	1 kΩ resistor	Vishay Precision Group	CRCW06031K00FKEAHP
R18, R27, R28	100 kΩ resistors	Multicomp	MC 0.063W 0603 1% 100K
S1	Toggle switch	Tyco	TT11EGPC104
U1	External reference	Analog Devices	ADR4525BRZ
U3	I ² C serial EEPROM	Microchip Technology	24LC32A/SN
U4	Single-channel, 16-bit DAC with dynamic power control	Analog Devices	AD5758BCPZ
VLOGIC_SOURCE	3-pin, 2 row header	Multicomp Company	2213S-06G

NOTES

**ESD Caution**

ESD (electrostatic discharge) sensitive device. Charged devices and circuit boards can discharge without detection. Although this product features patented or proprietary protection circuitry, damage may occur on devices subjected to high energy ESD. Therefore, proper ESD precautions should be taken to avoid performance degradation or loss of functionality.

Legal Terms and Conditions

By using the evaluation board discussed herein (together with any tools, components documentation or support materials, the "Evaluation Board"), you are agreeing to be bound by the terms and conditions set forth below ("Agreement") unless you have purchased the Evaluation Board, in which case the Analog Devices Standard Terms and Conditions of Sale shall govern. Do not use the Evaluation Board until you have read and agreed to the Agreement. Your use of the Evaluation Board shall signify your acceptance of the Agreement. This Agreement is made by and between you ("Customer") and Analog Devices, Inc. ("ADI"), with its principal place of business at One Technology Way, Norwood, MA 02062, USA. Subject to the terms and conditions of the Agreement, ADI hereby grants to Customer a free, limited, personal, temporary, non-exclusive, non-sublicensable, non-transferable license to use the Evaluation Board FOR EVALUATION PURPOSES ONLY. Customer understands and agrees that the Evaluation Board is provided for the sole and exclusive purpose referenced above, and agrees not to use the Evaluation Board for any other purpose. Furthermore, the license granted is expressly made subject to the following additional limitations: Customer shall not (i) rent, lease, display, sell, transfer, assign, sublicense, or distribute the Evaluation Board; and (ii) permit any Third Party to access the Evaluation Board. As used herein, the term "Third Party" includes any entity other than ADI, Customer, their employees, affiliates and in-house consultants. The Evaluation Board is NOT sold to Customer; all rights not expressly granted herein, including ownership of the Evaluation Board, are reserved by ADI. CONFIDENTIALITY. This Agreement and the Evaluation Board shall all be considered the confidential and proprietary information of ADI. Customer may not disclose or transfer any portion of the Evaluation Board to any other party for any reason. Upon discontinuation of use of the Evaluation Board or termination of this Agreement, Customer agrees to promptly return the Evaluation Board to ADI. ADDITIONAL RESTRICTIONS. Customer may not disassemble, decompile or reverse engineer chips on the Evaluation Board. Customer shall inform ADI of any occurred damages or any modifications or alterations it makes to the Evaluation Board, including but not limited to soldering or any other activity that affects the material content of the Evaluation Board. Modifications to the Evaluation Board must comply with applicable law, including but not limited to the RoHS Directive. TERMINATION. ADI may terminate this Agreement at any time upon giving written notice to Customer. Customer agrees to return to ADI the Evaluation Board at that time. LIMITATION OF LIABILITY. THE EVALUATION BOARD PROVIDED HEREUNDER IS PROVIDED "AS IS" AND ADI MAKES NO WARRANTIES OR REPRESENTATIONS OF ANY KIND WITH RESPECT TO IT. ADI SPECIFICALLY DISCLAIMS ANY REPRESENTATIONS, ENDORSEMENTS, GUARANTEES, OR WARRANTIES, EXPRESS OR IMPLIED, RELATED TO THE EVALUATION BOARD INCLUDING, BUT NOT LIMITED TO, THE IMPLIED WARRANTY OF MERCHANTABILITY, TITLE, FITNESS FOR A PARTICULAR PURPOSE OR NONINFRINGEMENT OF INTELLECTUAL PROPERTY RIGHTS. IN NO EVENT WILL ADI AND ITS LICENSORS BE LIABLE FOR ANY INCIDENTAL, SPECIAL, INDIRECT, OR CONSEQUENTIAL DAMAGES RESULTING FROM CUSTOMER'S POSSESSION OR USE OF THE EVALUATION BOARD, INCLUDING BUT NOT LIMITED TO LOST PROFITS, DELAY COSTS, LABOR COSTS OR LOSS OF GOODWILL. ADI'S TOTAL LIABILITY FROM ANY AND ALL CAUSES SHALL BE LIMITED TO THE AMOUNT OF ONE HUNDRED US DOLLARS (\$100.00). EXPORT. Customer agrees that it will not directly or indirectly export the Evaluation Board to another country, and that it will comply with all applicable United States federal laws and regulations relating to exports. GOVERNING LAW. This Agreement shall be governed by and construed in accordance with the substantive laws of the Commonwealth of Massachusetts (excluding conflict of law rules). Any legal action regarding this Agreement will be heard in the state or federal courts having jurisdiction in Suffolk County, Massachusetts, and Customer hereby submits to the personal jurisdiction and venue of such courts. The United Nations Convention on Contracts for the International Sale of Goods shall not apply to this Agreement and is expressly disclaimed.